





**SNAP-TITE®  
Connectors**

With spring steel clip. For NM  
• SE • MC • Flex • AC cable.  
For steel and aluminum  
jacketed cables. Zinc die-cast.

CATALOG NUMBER	UPC/DCI/NAED MFG #01 8997	TRADE SIZE	KO SIZE	UNIT PKG	STD PKG	DIM A	DIM B	DIM C	CABLE RANGE
840ST	80070	3/8	1/2	100	1000	.485	.879	.858	.225-.612
8400ST	80074	3/8	1/2	100	1000	.485	.879	.858	.225-.612

Refer to pages C-12 and C-13 for complete cable ranges.

SNAP-TITE® products have been tested and listed by UL in accordance with UL's ground fault requirements. For additional information see page 6.

**For connectors that cost less and install faster see page C-8.**

PATENTED.



840ST



8400ST

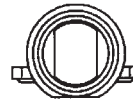

840ST

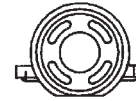

8400ST

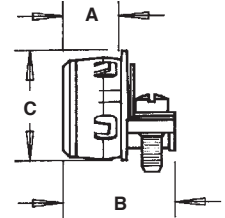

**NM Cable  
Connector**

For NM cable. Zinc die-cast.

CATALOG NUMBER	UPC/DCI/NAED MFG #01 8997	TRADE SIZE	KO SIZE	UNIT PKG	STD PKG	DIM A	DIM B	DIM C	CABLE RANGE
841	00841	3/8	1/2	100	1000	.422	.825	1.105	.225-.612

Refer to pages C-12 and C-13 for complete cable ranges.

**For connectors that cost less and install faster see page C-8.**

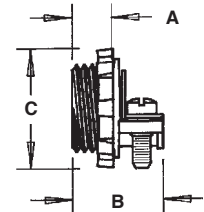

**SNAP-TITE®  
Connector**

With spring steel clip. For NM  
cable. Zinc die-cast.

CATALOG NUMBER	UPC/DCI/NAED MFG #01 8997	TRADE SIZE	KO SIZE	UNIT PKG	STD PKG	DIM A	DIM B	DIM C	CABLE RANGE
841ST	80068	3/8	1/2	100	1000	.510	.912	.920	.225-.612

Refer to pages C-12 and C-13 for complete cable ranges.

SNAP-TITE® products have been tested and listed by UL in accordance with UL's ground fault requirements. For additional information see page 6.

PATENTED.

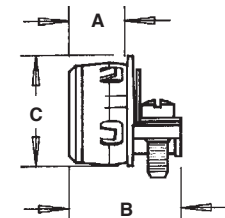



**SNAP-TITE®  
Connector**

With spring steel clip.  
For NM • SE cable.  
Zinc die-cast.



CATALOG NUMBER	UPC/DCI/NAED MFG #01 8997	TRADE SIZE	KO SIZE	UNIT PKG	STD PKG	DIM A	DIM B	DIM C	CABLE RANGE
842ST	80084	3/4	3/4	50	500	.510	1.070	1.200	.300-.780

SNAP-TITE® products have been tested and listed by UL in accordance with UL's ground fault requirements. For additional information see page 6.

PATENTED.

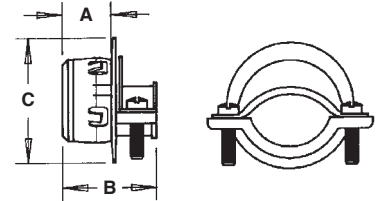

**Cable Connectors**

For NM • SE • MC • AC cable.  
For steel and aluminum jacketed cables. Zinc die-cast.



CATALOG NUMBER	UPC/DCI/NAED MFG #01 8997	TRADE SIZE	KO SIZE	UNIT PKG	STD PKG	DIM A	DIM B	DIM C	CABLE RANGE
840†	00840	3/8	1/2	100	1000	.422	.825	1.105	.225-.612
8400†	08400	3/8	1/2	100	1000	.422	.825	1.105	.225-.612
8401†	08401	3/8	1/2	100	1000	.422	.825	1.105	.225-.612
8402	08402	3/4	3/4	50	500	.533	1.093	1.395	.375-.780

Refer to pages C-12 and C-13 for complete cable ranges.

\*Listed for MC only. UL# E123751.

†For connectors that cost less and install faster see page C-8.

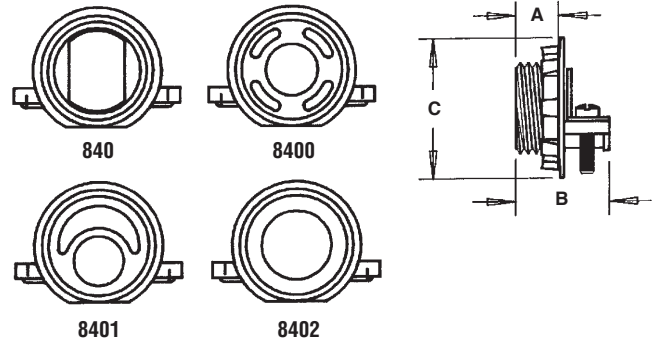

**Combination  
Coupling**

EMT to NM. Zinc die-cast.



CATALOG NUMBER	UPC/DCI/NAED MFG #01 8997	EMT SIZE	UNIT PKG	STD PKG	DIM A	DIM B	CABLE RANGE
8600	08600	1/2	50	500	1.162	1.090	.250-.612

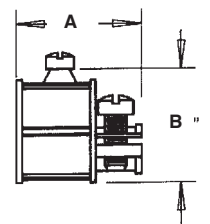



**Cable Connectors**

For NM • SEU cable. Zinc die-cast.



CATALOG NUMBER	UPC/DCI/NAED MFG #01 8997	TRADE SIZE	KO SIZE	UNIT PKG	STD PKG	DIM A	DIM B	DIM C	MAX OPENING
842	00842	3/4	3/4	50	500	.481	1.000	1.375	.730
843	00843	1	1	25	250	.780	1.284	1.670	.850
844	00844	1-1/4	1-1/4	10	100	.710	1.312	2.030	.900
848*	00848	1-1/2	1-1/2	10	50	.817	1.453	2.300	.960
849*	00849	2	2	10	50	.823	1.590	2.900	.960

\*UL# E66990 - Service entrance ONLY.

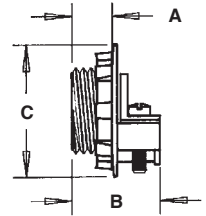

**Cable Connectors**

For NM • SE cable. Zinc die-cast.



CATALOG NUMBER	UPC/DCI/NAED MFG #01 8997	TRADE SIZE	KO SIZE	UNIT PKG	STD PKG	DIM A	DIM B	DIM C	MAX OPENING
842	00842	3/4	3/4	50	500	.481	1.000	1.375	.730
843S	84310	1	1	25	250	.780	1.284	1.670	.970
844S	84410	1-1/4	1-1/4	10	100	.710	1.312	2.030	1.160
848S	84810	1-1/2	1-1/2	10	50	.817	1.453	2.300	1.420
849S	84910	2	2	10	50	.823	1.590	2.900	1.750

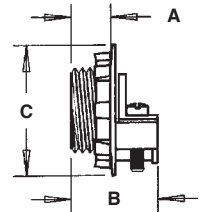

**2-Hole Cable Straps**

For SEU cable. Plated steel.



CATALOG NUMBER	UPC/DCI/NAED MFG #01 8997	WIRE SIZE	UNIT PKG	STD PKG	DIM A	DIM B	DIM C
C STRAP	37500	8/3-3/3	50	200	2.410	.750	.470
E STRAP	43625	2/3	50	200	1.080	.750	.575
H STRAP	82990	1/0-2/0	50	200	3.183	.755	.750
K STRAP	83770	3/0, 4/0	50	200	3.500	.755	.890

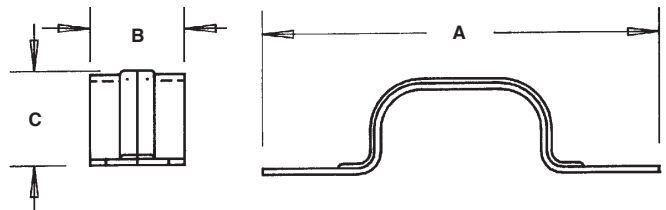



## Gland-Type Service Entrance Cable Connectors

Twin screw type. Zinc die-cast.



CATALOG NUMBER	UPC/DCI/NAED MFG #01 8997	TRADE SIZE	KO SIZE	UNIT PKG	STD PKG	DIM A	DIM B	DIM C	DIM D	CABLE RANGE
WC1001	53101	1	1	1	50	1.400	.615	1.500	2.230	.630 x 1.000

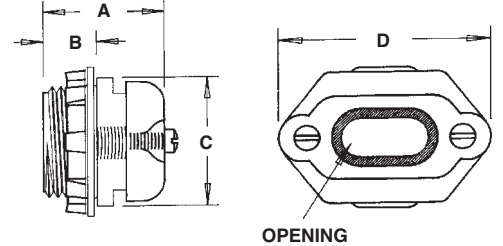

## UF Connectors

Compression type for underground feeder cable. Zinc die-cast.



CATALOG NUMBER	UPC/DCI/NAED MFG #01 8997	TRADE SIZE	KO SIZE	UNIT PKG	STD PKG	DIM A	DIM B	DIM C	CABLE RANGE
UF50	36500	1/2	1/2	25	100	1.792	.630	1.042	14/2-12/2
UF75	51302	3/4	3/4	10	50	1.792	.630	1.042	14/3-10/2

Low profile design to fit the new smaller UF cables as well as standard sizes.

PATENTED.

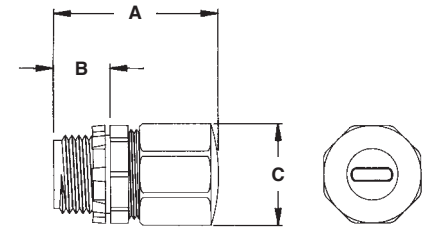
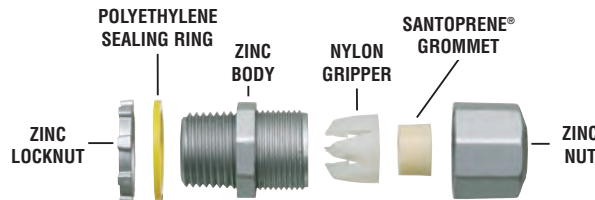

## Non-Metallic UF Connectors

Compression type for underground feeder cable.



CATALOG NUMBER	UPC/DCI/NAED MFG #01 8997	TRADE SIZE	KO SIZE	UNIT PKG	STD PKG	DIM A	DIM B	DIM C	CABLE RANGE
NMUF50	55040	1/2	1/2	25	100	1.792	.630	1.042	14/2-12/2
NMUF75	54367	3/4	3/4	10	50	1.792	.630	1.042	14/3-10/2

Low profile design to fit the new smaller UF cables as well as standard sizes.

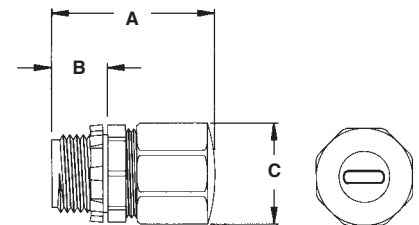
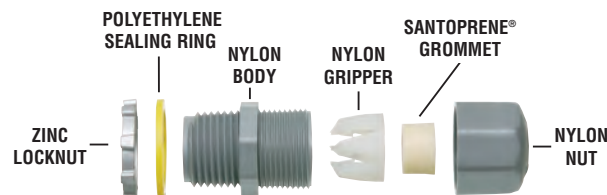



## Gland-Type Service Entrance Cable Connectors

Zinc die-cast.



CATALOG NUMBER	UPC/DCI/NAED MFG #01 8997	TRADE SIZE	DIM A	DIM B	DIM C	GROMMET OPENING MAX ID	GROMMET OPENING MIN ID	INSULATED CONDUCTOR SIZE AWG	UNINSULATED CONDUCTOR SIZE AWG	STD PKG
WC1004	53104	1	1.970	.750	1.775	.56 x .82	.44 x .81	4-7	4	50
WC1006	53106	1	1.970	.750	1.775	.50 x .77	.40 x .71	6-7	6	50
WC1008	53108	1	1.970	.750	1.775	.40 x .67	.32 x .50	8-1	8	50
WC1252	53125	1-1/4	1.943	.750	1.916	.59 x .98	.51 x .93	2-7	2	50
WC1252N	53122	1-1/4	1.943	.750	1.916	.66 x 1.10	.57 x 1.05	1-19	2	50
WC1501	53151	1-1/2	2.390	.750	2.500	.70 x 1.18	.65 x 1.10	1/0-19	1/0	10
WC1502	53152	1-1/2	2.390	.750	2.500	.86 x 1.36	.70 x 1.20	2/0-19	2/0	10
WC2001	53201	2	2.420	.750	2.500	.70 x 1.18	.65 x 1.10	1/0-19	1/0	10
WC2002	53202	2	2.420	.750	2.500	.85 x 1.35	.70 x 1.20	2/0-19	2/0	10
WC2003	53203	2	2.420	.750	2.500	.86 x 1.38	.75 x 1.30	3/0-19	3/0	10
WC2004	53204	2	2.420	.750	2.850	1.03 x 1.59	.88 x 1.42	4/0-19	4/0	10
WC2004N	53205	2	2.420	.750	2.500	1.11 x 1.75	.94 x 1.58	4/0-19	4/0	10



E66990 LR49636

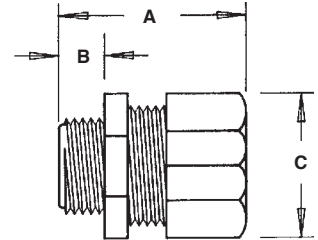

## NM Cable Connectors

Plated steel.



CATALOG NUMBER	UPC/DCI/NAED MFG #01 8997	WIRE SIZE	UNIT PKG	STD PKG	DIM A	DIM B	MIN/MAX OPENING
BT50*	24050	14/2-8-3	100	1000	1.500	.720	.250-.600
BT75*	24075	8/2-6/2	50	500	1.764	.811	.124-.934
BT125	24125	2/0-3/0	25	250	2.245	.842	.275-.900
BT150	24150	4/0	20	200	2.705	.835	.275-.900

\*UL only.

Refer to pages C-12 and C-13 for complete cable ranges.



E28474

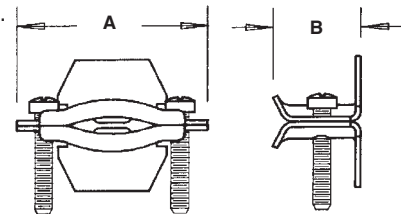



## Non-Metallic Push-In Connectors

For NM and flexible cord.



NM840



NM841

CATALOG NUMBER	UPC/DCI/NAED MFG #01 8997	TRADE SIZE	KO SIZE	UNIT PKG	STD PKG	DIM A	DIM B	DIM C
NM840	54840	3/8	1/2	100	1000	1.031	.375	.965
NM841	54841	1/2	1/2	50	500	1.340	.475	1.125
NM842	54842	3/4	3/4	25	250	1.510	.475	1.200
NM843	54843	1	1	25	250	1.637	.475	1.500
NM844	50175	1-1/4	1-1/4	10	100	2.085	.475	2.012

Refer to pages C-12 and C-13 for complete cable ranges.



E28474 LR49636

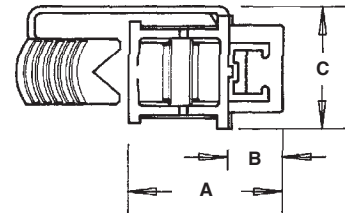

### Installation Instructions

1. Disconnect electrical power.  
Push the connector into knockout.
2. Install required cables or cords.
3. Place wedge in connector slot and lock tight with a pair of pliers. Tightened wedge provides strong, positive grip.



## Non-Metallic Cable Connectors

For non-metallic sheathed cable. One piece construction. Listed for 1 or 2 cables. Holds cables securely and handles a wide range of cable sizes.



CATALOG NUMBER	UPC/DCI/NAED MFG #01 8997	TRADE SIZE	KO SIZE	UNIT PKG	STD PKG	DIM A	DIM B	DIM C
NM74	54510	3/8	1/2	100	1000	1.289	1.029	.875
NM75	54513	3/4	3/4	25	250	1.289	1.271	1.117

Refer to pages C-12 and C-13 for complete cable ranges.

PATENTED.



E28474 LR49636

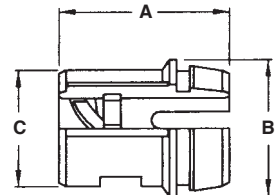



## Black Button™ Non-Metallic Push-In Connectors

For NM cable.



NM94



NM95



NM96

The *Black Button* is not only the lowest cost NM connector on the market, but offers the fastest method of installing single or multiple cables.

For multiple cable installations:

- Two cables may be inserted together or individually.
- A second cable may be added without removing the first.

Plus, the NM94 meets UL and CSA requirements for single or multiple cables.

CATALOG NUMBER	UPC/DCI/NAED MFG #01 8997	TRADE SIZE	KO SIZE	UNIT PKG	STD PKG	DIM A	DIM B	DIM C
NM94	05488	3/8	1/2	250	1000	1.010	.450	.096
NM940	72156	3/8	1/2	100	1000	1.010	.450	.096
NM95	10956	3/4	3/4	50	500	1.293	.597	.096
NM96	72158	1	1	25	250	1.648	.683	.156

Refer to pages C-12 and C-13 for complete cable ranges.

PATENTED.



E28474 LR49636

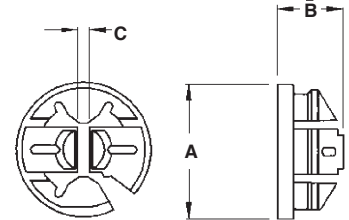

### Installation Instructions

1. Disconnect electrical power. Insert connector into knockout.
2. Push non-metallic sheathed cable into the connector to desired length.



### Removal

If necessary, the NM94 series may be removed with a screwdriver.

1. Slip screwdriver under NM connector and twist.
2. NM94 pops out of the knockout.

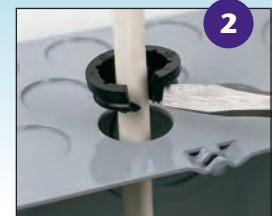

## Reduce your Labor Costs!

Arlington's NM94 costs just 6¢ to install.  
Compare this to 16¢ for NM841 and 40¢ for 841\*.

- Listed for both 1 or 2 cables.
- Installs easily... snaps into KO using light finger pressure.
- Cables insert without a struggle for a smooth installation.
- Holds wires securely - meets and exceeds UL pullout tests.
- Simple to remove with a twist of a screwdriver.
- Arlington's Black Button™ is the lowest cost NM cable connector available today.

\* Labor costs are based on a rate of \$30.00 per hour.





## Non-Metallic Bushings for Metal Studs



**FITS A STANDARD 1" KNOCKOUT**

CATALOG NUMBER	UPC/DCI/NAED MFG #01 8997	STUD SIZE	STD PKG	DIM A	DIM B	DIM C	DIM D
SB13	40115	2 x 4	500	5.670	2.500	.505	1.300
SB130	40130	2 x 4	100	5.670	2.500	.505	1.300

These bushings fit existing irregular shaped holes in metal studs, alleviating the need to punch holes in metal studs, weakening the structural member. Use these bushings to comply with paragraph 300-4(b)(1) of the 2005 NEC code which states that: "In both exposed and concealed locations where nonmetallic-sheathed cables pass through either factory or field punched, cut, or drilled slots or holes in metal members, the cable shall be protected by bushings or grommets covering all metal edges and securely fastened in the opening prior to installation of the cable."



E161207 LR49636

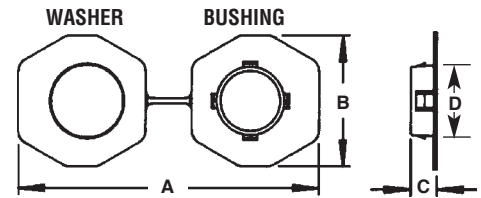

### Installation Instructions

To install these bushings in an irregular shaped hole, pass one end of the joined connector through the hole in the stud. Snap the bushing and the washer ends together. There's no need to separate the two halves. If a punched hole is required, the SB13 can be installed in a standard 1" trade size, round punched hole (1-3/8" diameter). Snap the bushing end into the hole.

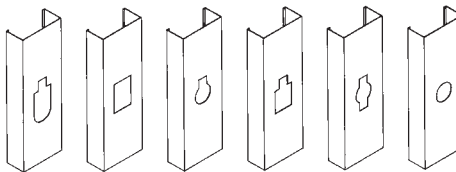
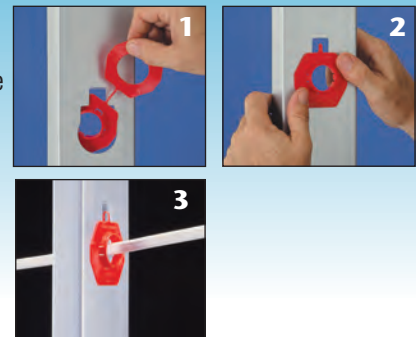

Common hole configurations in metal studs.

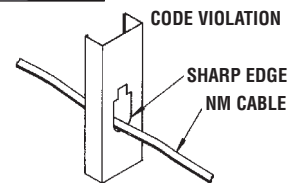

## Non-Metallic Bushings for Metal Studs



CATALOG NUMBER	UPC/DCI/NAED MFG #01 8997	TRADE SIZE	STD PKG	DIM A	DIM B	DIM C
SB1	18001	1/2	1000	.940	.470	.700
SB10	18010	1/2	100	.940	.470	.700
SB3	18050	1	1000	1.750	.400	1.150
SB30	18053	1	100	1.750	.400	1.150

Note: See page M-9 for larger sizes.



E161207 LR49636

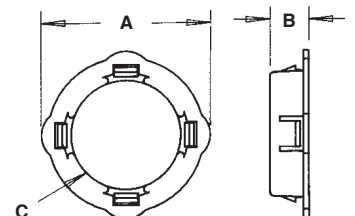



## CS6 Cable Support



CATALOG NUMBER	UPC/DCI/NAED MFG #01 8997	STD PKG	DIM A	DIM B	DIM C
CS6	71006	500	1.750	2.000	.563
CS60	71060	100	1.750	2.000	.563

**Note:** For position only. For *support clips* for AC/MC cable see NM310 on page E-22.

PATENTED.



E161207 LR49636

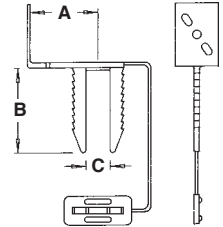

### Holds...

- Six 14/2 NM cables *or*
- Five 12/2 NM cables *or*
- Four 10/2 NM cables *or*
- One 14/2 to 10/2 MC/AC cable

### Installation Instructions

Simply position the CS6 in the desired location and insert a sheet metal screw into a steel or wood stud or use a nail in a wood stud. Cable or cables can then be placed between serrated forks. Install mating washer over serrated forks to secure cable/cables.

**Metal Stud**



**Wood Stud**



**Alternate fastening option: Use staple**

## Cable Standoffs

Positions non-metallic sheathed cable, phone/data cable, and coaxial cable. Installs with a screw or nail. Nail included with CS4.



CS4



CS7

CATALOG NUMBER	UPC/DCI/NAED MFG #01 8997	STD PKG	DIM A	DIM B	DIM C
CS4	50174	100	4.100	.750	1.200
CS7*	71007	100	3.490	.880	.740

\*UL and CSA only

**Note:** For position only.



E161207 LR49636

### Features and Benefits

- Positions cables at a safe distance from nailing surface
- CS4 provides a neat, organized cable installation and prevents tangles
- CS7 positions cable 2" from a furring strip or 2x4 stud
- CS7 features positive lock to keep cables in place
- Positions both flat and round NM cables
- Complies with 2005 NEC Article 300-4d

### CS7 Holds...

- Up to five runs of 12/2 non-metallic sheathed cable.
- Up to eight runs of Cat 5 cable.
- Up to four runs of Cat 6 cable.
- Up to five runs of coaxial cable.

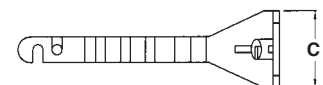
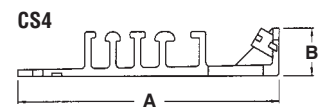

### CS4 Holds...

- One 14/3 to one 10/3
- Three 14/2 W/G to three 10/3



## CS2 & CS20SC Cable Supports

Supports up to four 14/2 - 10/2 flat (any combination) and two 14/3 - 10/3 (any combination) NM cables.



CS2, CS20



#8 self-tapping sheet metal screw  
CS20SC

CATALOG NUMBER	UPC/DCI/NAED MFG #01 8997	UNIT PKG	STD PKG	DIM A	DIM B	DIM C
CS2	71002	500	500	2.650	2.530	.500
CS20	71020	100	100	2.650	2.530	.500
CS20SC	71025	100	100	2.704	2.563	.500
CS20BAG	71022	25	100	2.650	2.530	.500

PATENTED. ADDITIONAL PATENTS PENDING.



E161207 LR49636

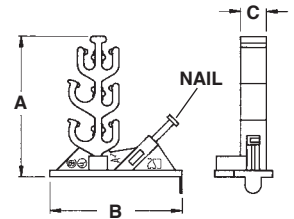

### Installation Instructions

#### To install the CS2:

Position the CS2 in the desired location on a wood stud and drive in nail. Insert cable or cables.

#### To install the CS20SC:

Position the CS20SC in the desired location on a wood or metal stud and tighten self-tapping screw. Insert cable or cables.

#### CS2 on Wood Stud



#### CS20SC on Metal Stud



## 1-Hole Aluminum Straps

For service entrance cable. Aluminum.



CATALOG NUMBER	UPC/DCI/NAED MFG #01 8997	WIRE SIZE	UNIT PKG	STD PKG	DIM A	DIM B	DIM C	DIM D
3232	32320	3 #8 to 3 #4	100	1000	2.078	.775	.600	.265
3282	03282	3 #1/0 to 3 #2/0	100	1000	2.488	.940	.720	.265
3284	32840	3 #3/0 to 3 #4/0	100	1000	2.710	1.218	1.000	.325

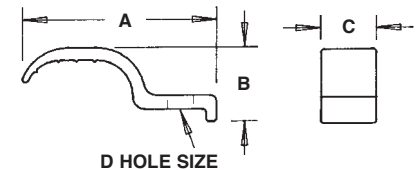

## 1-Hole Steel Straps

For service entrance cable. Plated steel.



CATALOG NUMBER	UPC/DCI/NAED MFG #01 8997	WIRE SIZE	UNIT PKG	STD PKG	DIM A	DIM B	DIM C	DIM D
301	00301	8/3-3/3	100	1000	1.687	.442	.565	.265
303	00303	2/3	100	1000	1.830	.530	.575	.265
313S	00133	1, 1/0 or 2/0	100	1000	2.472	.770	1.000	.325
314S	00014	3/0, 4/0	100	1000	2.790	.920	1.000	.330

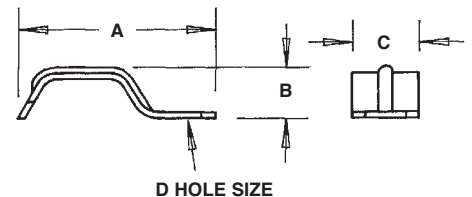



FITTINGS	CABLE RANGE		TYPE	
<b>1/2" KO</b>				
BT50		1-14/2 to 1-8/3 2-12/3 4-14/2	NM NM NM	
841, 841ST	1-14/2 & 1-14/3 1-14/2 & 1-12/3 1-12/2 & 1-14/3 1-12/2 & 1-12/3 2-14/2 & 1-14/3 2-14/2 & 1-12/3	1-14/2 to 10/2 1-14/3 to 10/3 2-14/2 to 10/2 1-14/2 & 1-12/2 1-14/2 & 1-10/2 1-12/2 & 1-10/2 3-14/2	NM NM NM NM NM NM NM	
NM74	1-14/2 to 1-10/2 1-14/3 to 1-10/3	2-14/2 to 2-10/2 2-14/3	NM NM	
NM94	1-14/2 to 1-10/2 1-14/3 to 1-10/3	2-14/2 to 2-10/2 2-14/3 to 2-12/3	1-14/2 and 1-12/2 1-14/2 and 1-10/2 1-12/2 and 1-10/2 1-14/3 and 1-12/3	NM NM NM NM
NM840		1-14/2 to 1-10/2	NM	
NM841	1-14/2 to 6/2 1-14/3 to 10/3 1-14/2 & 1-12/2 1-14/2 & 1-10/2 1-12/2 & 1-10/2 1-14/2 & 1-14/3 1-14/2 & 1-12/3 1-12/2 & 1-14/3 1-12/2 & 1-12/3 1-8/2 & 1-14/2 1-8/2 & 1-12/2	2-14/2 to 10/2 2-14/2 & 1-14/3 2-14/2 & 1-12/3 2-14/2 & 1-12/2 2-14/2 & 1-10/2 2-14/3 3-14/2 1-14/2 & 2-12/2 1-14/2 & 2-10/2 1-6/2	NM NM NM NM NM NM NM NM NM NM NM	
840, 840ST 8400, 8400ST 8401		1-14/2 to 10/2 1-14/3 to 10/3 2-14/2 to 10/2 1-14/2 & 1-12/2 1-14/2 & 1-10/2 1-12/2 & 1-10/2	NM NM NM NM NM NM	
<b>3/4" KO</b>				
BT75 842, 842ST NM842*		1-8/2 to 1-6/2 2-14/3 to 2-10/3 1-8/3 to 1-6/3 1-14/3 & 1-12/3 1-14/3 & 1-10/3 1-12/3 & 1-10/3 1-8/2 to 1-4/2	NM NM NM NM NM NM SE	

Continued next page



FITTINGS	CABLE RANGE				TYPE	
8402	2-10/2 3-14/2 to 3-10/2			1-8/2 to 1-6/2 2-14/3 to 2-10/3 1-8/3 to 1-6/3 1-14/3 & 1-12/3 1-14/3 & 1-10/3 1-12/3 & 1-10/3 1-8/2 to 1-4/2 1-.640 2-.448 1-.550 & 1-.375	NM NM NM NM NM NM SE SE Flex Cord Flex Cord	
NM75	1-6/2 1-6/3	1-8/2 1-8/3	1-10/2 1-10/3	2-14/2 2-12/2	2-10/2 2-10/3	NM NM
NM95	1-14/2 to 1-6/2 1-14/3 to 1-6/3		2-14/2 to 2-10/2 2-14/3 to 2-10/3		1-14/2 and 1-12/2 1-14/2 and 1-10/2 1-12/2 and 1-10/2 1-14/3 and 1-12/3	NM NM NM
NM842	3 to 4 14/2 to 10/2 plus any combination thereof.				2-10/2 & 1-14/3 to 2-10/2 & 1-12/3 1-14/2 & 1-12/2 & 1-14/3 1-14/2 & 1-10/2 & 1-14/3 1-14/2 & 1-12/2 & 1-12/3 1-14/2 & 1-10/2 & 1-12/3 1-12/3 & 1-14/2 1-12/3 & 1-8/2	NM NM NM NM NM NM NM
<b>1" KO</b>						
843, 843S	2-10/3 to 2-8/3 1-6/2 & 1-8/2 2-6/2 to 1-8/3 2-8/3 & 1-6/2 3-8/2 to 3-6/2	1-6/2 to 1-4/2 1-8/3 to 1-4/3 2-10/3 to 2-8/2 1-8/3 to 1-6/3 1-12/3 & 1-8/2		1-10/3 & 1-8/2 1-10/3 & 1-8/2 2-8/2 1-4/3 1-12/3 & 1-10/3	NM, SE NM, SE NM, SE NM, SE NM, SE	
NM843	2-10/3 and 2-8/2	1-8/3 to 1-4/3 1-8/3 and 2-6/2 2-8/3 and 1-6/2		3 to 6 14/3	NM NM NM	
Any combination of above with minimum Outer Diameter of .580 and a maximum Outer Diameter of .960.						
NM96	1-4/3 to 8/3	1-6/2 to 4/2			NM	
<b>1-1/4" KO</b>						
NM844				1-4/3 to 1-6/3 2-6/3 to 2-10/3 4-10/2 10-12/2 9-14/2 1-.750 1-.580 x .950	NM NM NM NM Flex Cord Flex Cord	