

Distance: SA1D

Analog Distance Detection Sensors

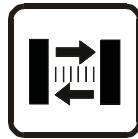

- Triangulation ensures high-precision when sensing the presence or position of objects
- Wide sensing range: 7.87" to 19.69" (200 to 500mm)
- Select analog output (20 to 4mA) for continuous values; use digital output (on/off); or use both together
- Far and near limits can be defined for detecting objects within a specified zone
- A ten-dot LED level meter provides a dynamic display of detected positions and also shows near and far settings
- Alarm output indicates when sensing conditions may result in inaccurate results

SA1D sensor provides versatile, accurate distance sensing for your specific application needs. Both in analog and digital output style for comparison.

The advantage of the SA1D is that the shape, size, material, and color do not detract from accurate measurement.

Dimensions (mm)

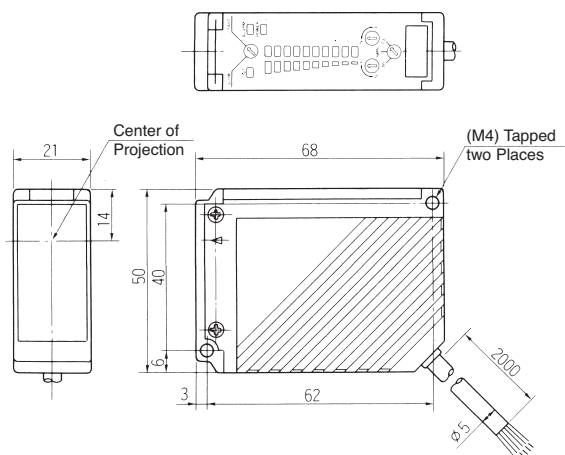

Wiring

Wire Color	Name	Function
Brown	+V	12 to 24V DC, 100mA (maximum)
Black	OUT	Digital Output, 30V DC, 100mA
Orange	ALM	Alarm Output, 30V DC, 100mA
Blue	GND	Power Ground (0 V)
White	ANALOG	Analog Output, 20 to 4mA
Shield	GND	Shield



An analog output line may be extended up to 33' (10m), as long as the cable used is equal to or superior to the cable provided. Other lines may be extended up to 164' (50m), using #22 AWG (0.3mm²) wire.

Specifications

		SA1D-LK4	SA1D-LL4		
PLCs Operator Interfaces Automation Software Power Supplies Sensors Communication & Networking	General Specifications	Power Voltage	12 to 24V DC ± 10% (ripple 10% maximum)	√	√
		Current Draw	100mA (maximum)	√	√
		Dielectric Strength	Not specified due to capacitor grounding	√	√
		Insulation Resistance	Not specified due to capacitor grounding	√	√
		Operating Temperature	0° to +55°C (performance will be adversely affected if the sensor becomes coated with ice)	√	√
		Operating Humidity	35 to 85% RH (avoid condensation)	√	√
		Storage Temperature	-20° to +70°C	√	√
		Vibration Resistance	Damage limits: 10 to 55Hz, amplitude 1.5mm p-p, 2 hours in each of 3 axes (power off)	√	√
		Shock Resistance	Damage limits: 500m/sec ² (approximately 50G), 5 shocks in each of 3 axes	√	√
		Extraneous Light Immunity	Sunlight: 10,000 lux; Incandescent light: 3,000 lux (maximum) — defined as the incident or unwanted light received by a sensor, unrelated to the presence or absence of the intended object	√	√
		Material	Housing: Diecast zinc; Filter and lens: Acrylic	√	√
		Degree of Protection	IP65	√	√
		Cable	Cable type: 5-core cabtyre cable 0.2mm ² , 6'-6-3/4" (2m) long	√	√
		Weight	Approximately 350g	√	√
		Dimensions	2.68"H x 0.83"W x 1.97"D (68mm H x 21mm W x 50mm D)	√	√

Function Specifications	Analog Output	20 to 4mA, 5V (maximum), fixed range	√	√
	Digital Output	NPN or PNP transistor open collector, 30V DC, 100mA (maximum), Residual: 1V (NPN), 2V (PNP)	√	√
	Alarm Output	NPN or PNP transistor open collector, 30V DC, 100mA (maximum), Residual: 1V (NPN), 2V (PNP)	√	√
	Level Meter (10-dot LED display)	Analog: Represents object distance corresponding to analog output on a 10-dot LED display Digital: Indicates near or far limit settings	√	√
	Out LED	On: When digital output is on	√	√
	Power LED	On: When power is on	√	√
	Alarm LED	On: When reflected light is excessive or insufficient	√	√
	Digital Output	Digital output and OUT LED turns on when object is within near and far limits	√	√
	Digital Output Setting	14-turn control for far/near setting (far and near limits can be set separately)	√	√
	Response Time	High-speed (F): 5ms (maximum) Normal speed (S): 50ms (maximum)	√	√
	Repeat Error	High-speed: 4% (maximum) Normal speed: 2% (maximum)	√	√
	Hysteresis	10% (maximum), defined as the difference between the operating point and the release point	√	√
	Light Source Element	Infrared LED (modulation mode)	√	√
	Wavelength	880nm (infrared LED)	√	√
	Receiver Element	Position sensitive device (PSD)	√	√
	Detectable Object	Opaque	√	√

Part Numbers

Function	Sensing Range	Reference Object	Output	Part Number
	200 to 500mm (7.87" to 19.69")	White: 75 x 75mm (2.95" x 2.95")	NPN	SA1D-LK4
	200 to 500mm (7.87" to 19.69")		PNP	SA1D-LL4

For information on accessories, see page 229.

Applications

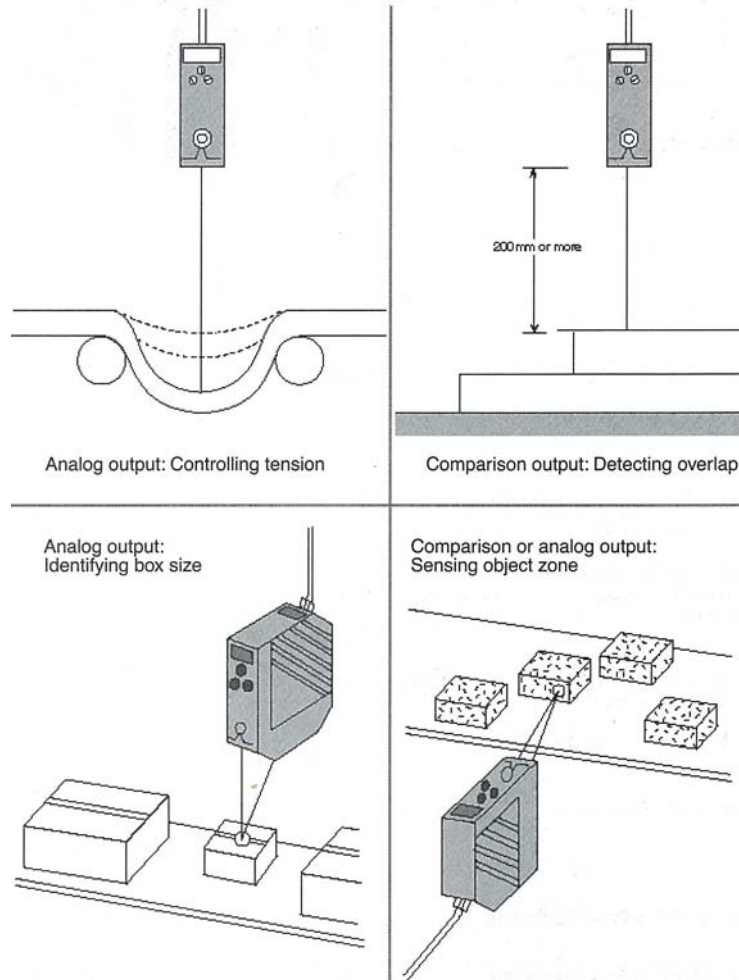

PLCs

Operator Interfaces

Automation Software

Power Supplies



Sensors

Communication & Networking







Application Sensors

Accessories



Brackets

Appearance	Item	Use with	Part Number
	Mounting bracket	S60, S62, S65	95ACC5330 (model ST-5020)
	Mounting bracket		95ACC5340 (model ST-5021)
	L shaped mounting bracket	S80	95ACC2260 (model ST-5037)

Connector Cables (for connector model sensors)

Appearance	Type & Length	Use with	Part No.
	5m axial 4-pole M12 cable	S51, S60, S62, DS1 (emitter) AS1 (emitter)	CS-A1-02-G-05
	5m radial 4-pole M12 cable		CS-A2-02-G-05
	5m axial 8-pole M12 cable	S65, S80	CS-A1-06-B-05
	5m axial 5-pole M12 cable	TL46, LD46, DS1 (receiver), AS1 (receiver)	CS-A1-03-G-05
	5m axial 4-pole M8 cable	SR21	CS-B1-02-G-05
	5m radial 4-pole M8 cable		CS-B2-02-G-05

Lenses

Appearance	Item	Use with	Part Number
	Plastic lens with 9mm focus	TL46	95ACC2540
	Plastic lens with 18mm focus		95ACC1030
	Plastic lens with 22mm focus		95ACC1000
	Plastic lens with 28mm focus		890000194
	Plastic lens with 40mm focus	TL46, LD46	95ACC1220

Diffuse-Reflected Light Fiber Optic Unit

Inspection Spot	Sensing Range	Use With	Part Numbers
ø 2.5 mm	10mm	SA1J, SA1J-F	SA9F-DA11
ø 5 mm	20mm		SA9F-DA12
ø 8 mm	30mm		SA9F-DA13

Lens Attachments

Description	Use With	Sensing Range	Part Number
For long range detection of opaque objects	SA9F-TS21	300mm	SA9Z-F11
	SA9F-TC21	200mm	
	SA9F-TM21	150mm	
Sideview attachment	SA9F-TS21	25mm	SA9Z-F12
	SA9F-TC21	20mm	
	SA9F-TM21	20mm	

Miscellaneous Accessories

Description	Use with		Part Number
Fiber cutter	All fiber units except heat resistant	HxLxD: 0.91" x 1.77" x 0.31" (23x 45 x 8Dmm) Included with fiber units; order replacement only	SA9Z-F01

Dimensions (mm)

95ACC5330 (model ST-5020)

95ACC5340 (model ST-5021)

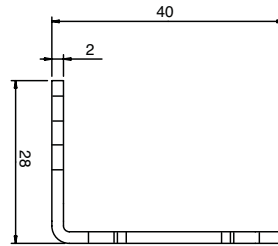
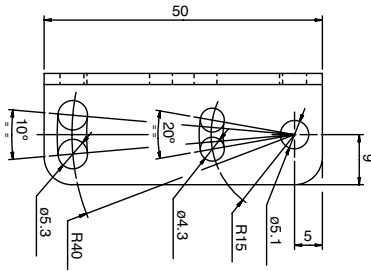
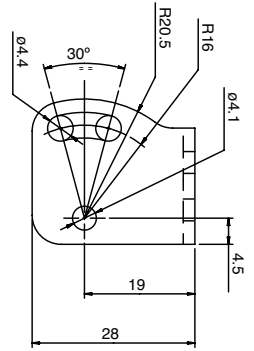
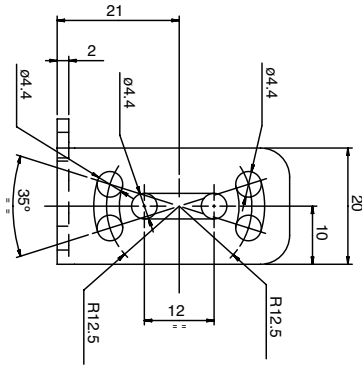
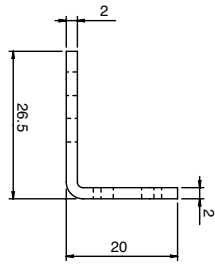
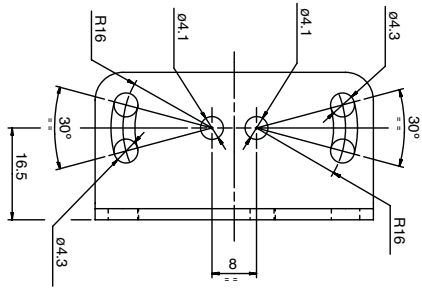

95ACC2260 (model ST-5037)

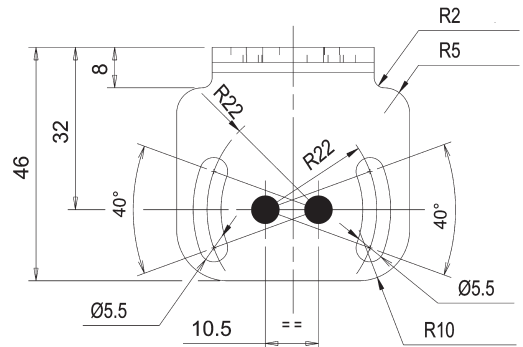
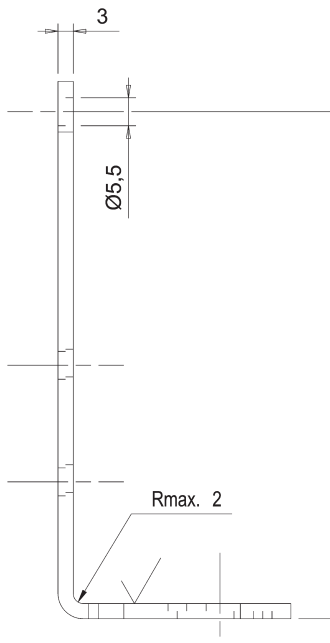
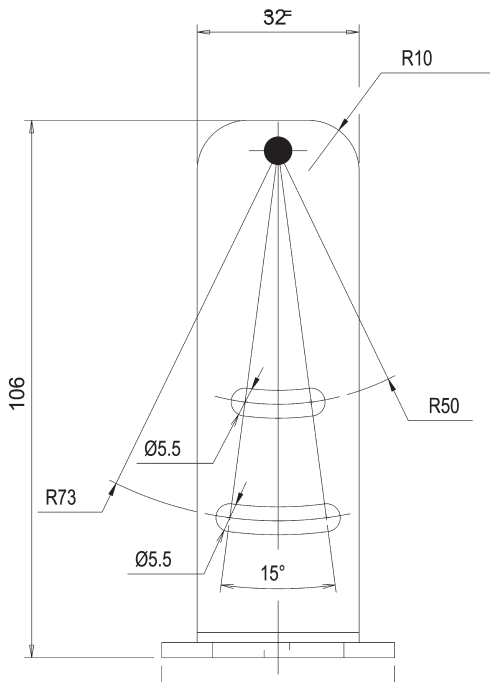

PLCs

Operator Interfaces

Automation Software

Power Supplies

Sensors

Communication & Networking

Dimensions (mm)

95ACC2540 (model No. 9 PMMA)

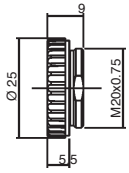

95ACC1030 (model No. 18 glass)

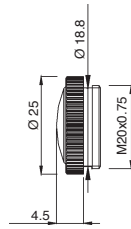

95ACC1000 (model No. 22 glass)

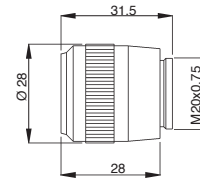

890000194 (model No. 28 glass)

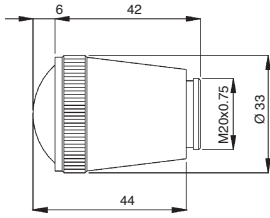

95ACC1220 (model No. 40 glass)

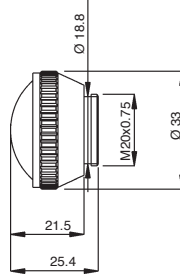

SA9Z-F01

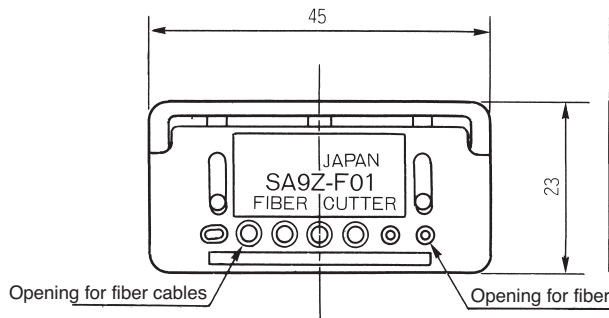

PLCs

Operator Interfaces

Automation Software

Power Supplies

Sensors

Communication & Networking

Laser Safety Information

Installation: If a sensor is installed so that the laser beam may shine or reflect into the eyes of a person passing by or working in the vicinity, place an opaque sheet of material in front of the beam to prevent potential eye injury. For people working near a laser sensor, protective glasses which screen out a significant amount of the harmful radiation are recommended at all times.

All laser sensors also include a remote interlock terminal which can be used to turn the laser on or off with an external switch, as required, to operate the sensor safely from a remote location.

To avoid exposure to harmful radiation, never disassemble a laser sensor.

WARNING: Do not allow class IIIa and IIIb laser beams to shine directly into the eyes. Do not allow lasers to reflect from a glossy, shiny, or reflective surface into the eyes.

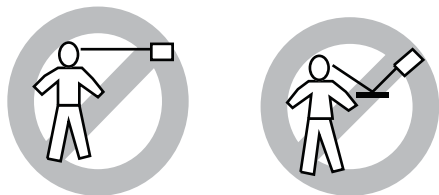

Labelling: IDEC laser sensors include **CDRH-approved** safety warnings shown below, in compliance with federal regulations of the **Center for Devices and Radiological Health**.

MX1C Miniature Laser Sensor:
Class IIIa Laser (670nm) Visible Beam

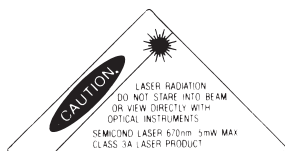

All Laser Sensors:
Identification and Certification

mfd.: **FEBRUARY 1997**

Product conforms to

21 CFR1040

MX1C Visible Laser:
Aperture Warning



General Information

Specifications

Do not operate a sensor under any conditions exceeding these specifications.

Do not operate a sensor under current and voltage conditions other than those for which the individual sensor is rated.

Do not exceed the recommended operating temperature and humidity. Although sensors are rated for operation below 0°C, this specification does not imply that performance characteristics will remain constant under prolonged freezing conditions. Continued exposure and the accompanying frost, ice, dew, and condensation which accumulate on the optical surface will adversely affect sensor performance.

To maintain performance characteristics, do not exceed vibration and shock resistance ratings while operating a sensor. In addition, avoid impacts to the sensor housing which are severe enough to adversely affect the waterproof characteristics.

IEC (International Electrotechnical Commission) Ratings

Sensors rated IP67 are resistant to moisture when occasionally immersed in water. Sensors rated IP64 through IP66 are resistant to moisture when occasionally subjected to splashing or when located in the vicinity of turbulent waters. These ratings do not imply that a sensor is intended for use under continual high-pressure water spray. Avoid such applications to maintain optimal sensor performance.

Sensors rated IP64 through IP67 are dust-tight and water-tight. For best performance, avoid using any sensor in an area where it will be subjected to heavy particle blasts and where dust, water, or steam will accumulate on the optical surface.

Start-up

Do not test the housing for dielectric strength and insulation resistance, since the housing is connected to the electronic circuit ground of a sensor. Do not perform dielectric strength and insulation resistance tests on electrical systems without disconnecting photoelectric sensors, as such testing may result in damage to the sensor.

Several lines of sensors, as noted in the individual operation sections, are provided with an internal circuit to turn an output off for a specified amount of time upon power-up. This delay is normal; it prevents a transient state when turning power on.

Optimum Performance

The optical surface of each sensor must be cleaned on a regular basis for continual superior performance. Use a soft cloth dipped in isopropyl alcohol to remove dust and moisture build-up.

IMPORTANT: Do not use organic solvents (such as thinner, ammonia, caustic soda, or benzene) to clean any part of a sensor.

All sensors experience signal inconsistencies under the influence of inductive noise. Do not use sensors in close proximity to transformers, large inductive motors or generators. Avoid using sensors in direct contact with sources of excessive heat. Also avoid operation in close proximity to welding equipment.

Light

Visible light is electromagnetic radiation with a wavelength between 390 and 770nm. White light is composed of all the visible spectrum components in equal quantity; the predominance of a specific wavelength determines the color of the light. Light Emitting Diodes (LEDs) are the most common light used in optoelectronics.

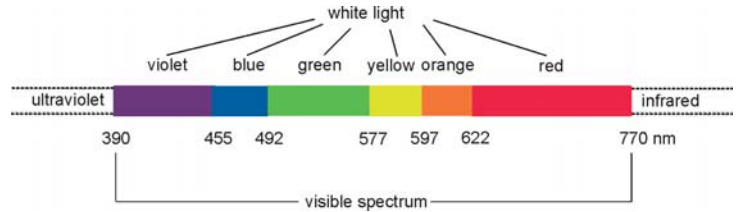

Transmission, Absorption, Reflection

When light hits an object three things take place at the same time: reflection (ρ), absorption (α) and transmission (τ); with parameters and ratios that vary according to the object themselves, which are then further differentiated by material, surface, thickness and/or color. These elements can be detected using a photoelectric sensor.

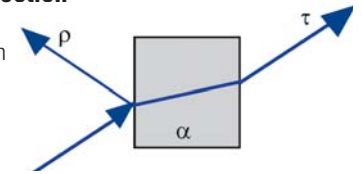

Extraneous Light

Bright, extraneous light such as sunlight, incandescent lights, or fluorescent lights may impair the performance of sensors in detecting color or light.

Make sure that extraneous light does not exceed recommended levels found in the individual specifications sections. When 500 lux is specified, this is equal to 50 footcandles. The average factory illumination is ordinarily below this level, except in areas where visual inspection is being performed. Only in such brightly lit areas is incident light of particular concern.

Unwanted light interference can often be avoided simply by making sure that the optical receiver is not aimed directly toward a strong light source. When mounting direction cannot be adjusted, place a light barrier between all nearby light sources and the receiver.

Through-beam Sensors



With through-beam sensors, the light emitter and receiver are contained in two different housings that are mounted one in front of the other. The light beam emitted by the emitter directly hits the receiver; each object that interrupts the beam is detected. This system is used to obtain large signal differences (when the light directly hits the receiver and when the object interrupts the beam) with the highest Excess Gain and the largest operating distance reaching up to 50m. These sensors can operate in the harshest environmental conditions, such as in the presence of dirt or dust. The disadvantage is that two units have to be wired (an emitter and receiver). The through-beam optic function operates typically in dark mode: the output is activated when the object interrupts the beam between the emitter and receiver.

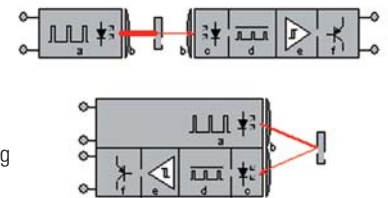

It is strongly recommended to avoid using any sensor where it will be continually subjected to elements which impair performance or cause corrosive damage to the sensor. In particular, avoid strong vibrations and shocks, corrosive gases, oils and chemicals, as well as blasts of water, steam, dust or other particles.

This document provided by Bar-Thorp Electric Co., Inc. 800-473-9123 www.bar-thorp.com

A slit attachment is available to modify the beam size of through-beam sensors. This option is recommended for detecting very small objects (near the size of the smallest object which a sensor can detect) or for eliminating light interference when sensors are mounted in close proximity.

Retro-reflective

Photoelectric sensors with this function contain both the emitter and receiver inside the same housing. The emitted light beam is reflected on the receiver due to a prismatic reflector; an object is detected when it interrupts the beam. Compared to the through-beam optic function, the signal difference is reduced (when the light is freely reflected by the reflector and when an object interrupts the beam) so Excess Gain is reduced and maximum operating distances can reach 12 meters. It is necessary to operate in clean environments without dirt or dust. A retro-reflective sensor typically operates in the dark mode: output is activated when an object interrupts the light beam between the sensor and reflector.

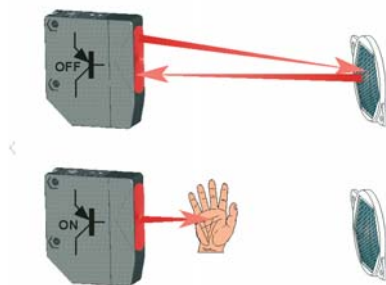

When installing sensors which detect reflected light, make sure that unwanted light reflections from nearby surfaces, such as the floor, walls, reflective machinery or stainless steel, do not reach the optical receiver.

Also, make sure that reflected-light sensors mounted in close proximity do not cause interfering reflections. When it is not possible to maintain the recommended clearance between sensors, as noted in the individual installation sections, provide light barriers between sensors.

Prismatic Reflector

A prismatic reflector is able to reflect incident light in a parallel manner, with a reflection coefficient higher than any other object for angles less than 15°. Typically the operating distance proportionally increases according to the reflector's dimensions. The reflector can rotate the incident light's polarization plane at 90°.

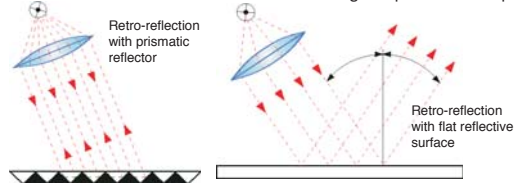

Polarized Retro-reflective

In presence of critical detection of objects with very reflective surfaces, such as shiny metals or mirrored glass, retroreflex sensors with polarized filters have to be used. In polarized retroreflex sensors, the emission light is polarized on a vertical plane, while the reception is obtained only through a polarized filter on a horizontal plane. A prismatic reflector rotates the light plane at a right angle, while the light reflected from the object maintains polarization plane unvaried and is blocked by the filter placed on the receiver. Consequently, only the light reflected by the prismatic reflector is received.



Retro-reflective for Transparent Objects

For detection of transparent objects, such as PET bottles or Mylar sheets, a low-hysteresis retro-reflective sensor (capable of detecting small signal differences) can be used. These sensors detect small signal differences that the light undergoes when it passes through a transparent object.



Diffuse Proximity

Photoelectric sensors with this function contain both the emitter and receiver inside the same housing. The emitted light beam is reflected on to the receiver directly by the object, which is detected without the need of prismatic reflectors. Proximity sensors represent the most economic and fastest mounting solution. However, they work with weaker signals compared to retro-reflective sensors. Excess Gain is reduced and operating distance, depending on the object's reflection degree, can only reach 2 meters.

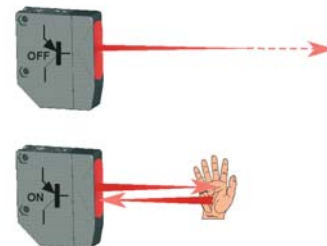

A proximity sensor normally operates in light mode: the output is activated when an object enters the detection area and reflects light emitted by the sensor.

Background Suppression

Background suppression sensors allow the operator to precisely set the maximum detection distance. The operating distance adjustment is not based upon the receiver's sensitivity, but is obtained through optic triangulation, mechanically acting on the lenses or photoelements angle or electronically using PSD (Position-Sensitive Detectors) receiving systems. Consequently the detection of an object is independent of other objects behind (or in the background), which are suppressed. Moreover, due to this adjustment method, all objects can be detected at the same distance independent of their color.

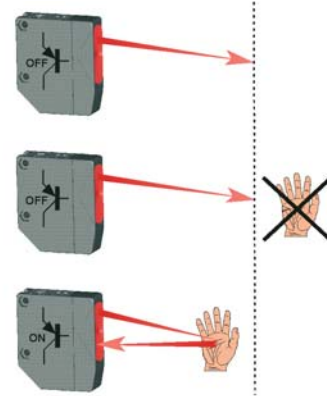

Distance Sensors

Distance sensors supply an analog signal of 0-10V or 4-20mA proportional to the measurement of the distance between the emitting optics and the target.



The main technologies involved are optic triangulation and time-of-flight. The first allows very precise measurements on short distances, while the second is ideal for medium and long distances.

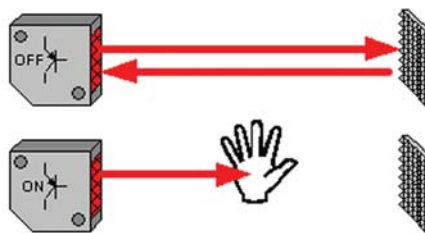

PLCs

Operator Interfaces

Automation Software

Power Supplies

Sensors

Communication & Networking

Slot Sensors

 A slot sensor is a version of a through-beam retro-reflective sensor, where the emitter and receiver are placed opposite each other on the inside of an U-shaped housing. Any target that passes through the internal slot interrupts the beam and is detected. Due to their construction, slot sensors are great for applications with short operating distances. The most typical slot sensor applications are hole or teeth detection on gears, label detection, or edge control and continuity of sheets or tapes. The emission is generally infrared light; however visible red or green emission versions are available and able to detect references such as registration marks, that present color contrasts on transparent film.

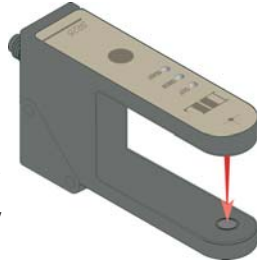

Contrast Sensors

 Contrast sensors (also defined as color mark readers) present a proximity function but, instead of detecting only the presence or absence of an object, they are able to distinguish between two surfaces. This accomplished by detecting the contrast produced by the different reflection degrees. In this manner a dark reference mark (low reflection) can be detected due to the contrast with a lighter surface (high reflection), or vice versa. In the presence of colored surfaces, the contrast is highlighted using an LED, typically red or green. For general purposes a white light is used because the full light spectrum detects the majority of contrasts. White light emission is obtained through lamps, or LEDs in most sensors, enabling the detection of very slight contrasts due to different surface treatments, even of the same material and color.

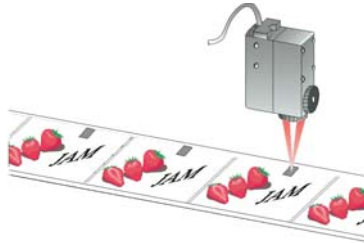

Contrast sensors are mainly used in automatic packaging machines for registration mark detection to synchronize folding, cutting and welding.

Contrast on White Background			
Mark Color	Red LED	Green LED	White LED
Red	no	medium	medium
Orange	low	medium	medium
Yellow	low	low	medium
Green	high	no	medium
Blue	high	medium	high
Violet	medium	high	high
Brown	low	medium	high
Black	high	high	high
Gray	medium	medium	medium
White	no	no	yes

Luminescence Sensors

 'Luminescence' is defined as visible light emission from fluorescent or phosphorous substances, due to electromagnetic radiation absorption. Luminescence sensors emit ultraviolet light, which is reflected at a higher wavelength (minor energy) on a fluorescent surface, shifting into the visible light spectrum. Ultraviolet light emission is obtained using special lamps, or LEDs in sensors. UV emission is modulated and the visible light reception is synchronized. Maximum immunity against external interferences, such as reflections caused by very shiny surfaces, is obtained. In addition, fluorescent targets, invisible to the human eye, can be detected. Luminescence sensors are used in various industries: detecting labels on glass or mirrors in pharmaceutical and cosmetic fields; selecting tiles marked with fluorescent marks in the ceramic industry; determining the presence of fluorescent glues on paper for automatic packaging; distinguishing cutting and sewing guides in textile manufacturing; checking fluorescent paints or lubricants in mechanical production.

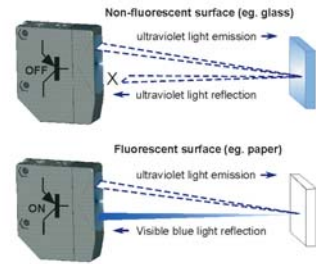

Color Sensors

 The color of an object depends on all the color components of the incident light which are being reflected, eliminating those which have been absorbed. The dominant color is defined as 'hue' and depends on the reflected light's wavelength. 'Saturation' indicates the pureness of the color with respect to white and is represented as a percentage. Hue and saturation together are defined as 'chromaticity'.

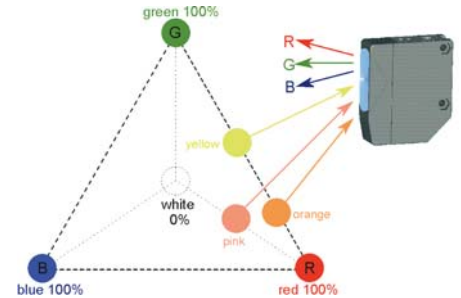

Color or chromatic sensors have a proximity function with generally three RGB LEDs for light emission. The color of an object is identified according to the different reflection coefficients obtained with red (R), green (G) and blue (B) light emissions. More simply, yellow can be identified by R=50% G=50% B=0% reflections; orange by R=75% G=25% B=0% reflections; pink by R=50% G=0% B=0% reflections; but possible combinations are really infinite. Color sensors operate only on reflection ratios and are not influenced by light intensity, defined as 'brilliance' or 'luminance'. There is a wide range of applications, ranging from quality and process controls, to automatic material handling for identification, orientation and selection of objects according to color.

Fiber Optic Sensors

 Universal functions of through-beam and proximity sensors, as well as application functions ranging from contrast and luminescence to color detection, can be obtained using fiber optic sensors. The optical fibers can be thought of as cables that transport light and can be used to place the sensor's optics in small spaces, or to detect very small objects.

An optical fiber is composed of cylindrical glass (or a plastic core), surrounded by Teflon or Silicon coating. The difference between the core and the coating refraction indexes allows the light to be diffused inside the fiber in a guided manner. The coating is covered by a plastic or metal sheath, which has an exclusively mechanical protection function. Fibers with a glass core and metal sheath are suitable for very high temperature uses, or for particular mechanical requirements. Plastic fibers, offering great adaptability, are the most diffused in all

PLCs

applications. Plastic optic fibers have a standard 2.2mm external diameter and generally have a cylindrical threaded metal head on the end used for mechanical mounting. These fibers are usually 1 and 2 meters in length as reductions in performance become significant with lengths over 5 meters. Plastic optic fibers can be shortened using a special fiber-cutting tool, but, it can only be used a limited number of times. Cutting the fiber with a non-sharp or non-perpendicular blade will reduce operating distance. High temperature, extra-flexible or high efficiency plastic optic fibers are also available.

Operator Interfaces

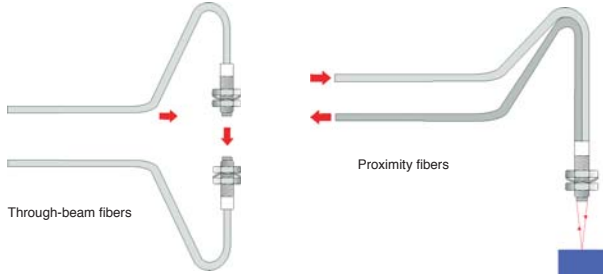

Automation Software

Laser Sensors

A LASER (Light Amplification by Stimulated Emission of Radiation) is an electronic device, such as a diode, that converts an energy source into a very thin and concentrated light beam, suitable for detecting very small objects or to reach very long operating distances. With reference to the safety of laser radiation (according to the EN60825-1 European standard) class 1 requires that the laser device is safe under reasonable operating conditions and is not dangerous for people in any situation; while class 2 states that the eye cannot be protected just by looking away or blinking, thus precautions must be adopted to avoid staring into the beam.



Power Supplies

IMPORTANT: Always consider safety when installing a laser sensor of any kind. Make sure that the laser beam cannot inadvertently shine into the eyes of people passing by or working in the vicinity. See safety information on page 232.

Mounting

Mounting brackets and hardware are included with sensors, where applicable. Use the hardware for mounting, along with washers and spring washers or lock nuts. Do not overtighten hardware. Overtightening causes damage to the housing and will adversely affect the waterproof characteristics of the sensor.

Best results can be obtained when the sensor is mounted so that the object sensed is in the center of the beam, rather than when the object is located near the edges of the sensing window. In addition, the most reliable sensing occurs when the majority of the objects being sensed are well within the sensing range, rather than at the extreme near and far limits.

Wiring

Avoid running high-voltages or power lines in the same conduit with sensor signal lines. This prevents inaccurate results or damage from induced noise. Use a separate conduit when the influence of power lines or electromagnetic equipment may occur, particularly when the distance of the wiring is extended.

IMPORTANT: Connect the sensor cables and wires as noted in the individual Wiring sections. Failure to connect as shown in wiring diagrams will result in damage to the internal circuit.

Sensors

Communication & Networking

When extending sensor cables and wires, make sure to use cables equal or superior to that recommended in the individual specifications sections.

When wiring terminals, be sure to prevent contact between adjoining terminals. When using ring or fork lug terminals, use the insulated sleeve style only. Each sensor terminal can accept only one ring or fork lug terminal.

Power Supply

Noise resistance characteristics are improved when a sensor is grounded to the 0V power terminal. If the 0V power terminal is not at ground potential, use a ceramic 0.01µF capacitor which can withstand 250V AC minimum.



When using a switching power supply, be sure to ground the FG terminal to eliminate high-frequency noise. The power supply should include an insulating transformer, not an autotransformer.

The compact PS5R-A power supply is the perfect companion item for most IDEC sensors. This power supply is only 1.77" (45mm) wide, 3.15" (80mm) tall, and 2.76" (70mm) deep. Call an IDEC representative for more details.

Part Number	Output Ratings
PS5R-A12	12V DC, 0.62A
PS5R-A24	24V DC, 0.32A

Miscellaneous

Strong magnetic fields may detract from the accuracy of the sensing measurements. Avoid mounting a sensor directly to machinery, since the housing is connected to the electronic circuit ground of the sensor. If it is necessary to mount a sensor on machinery, use the insulating plate and sleeve provided.

Glossary

Attenuation: Reduction of beam intensity as a result of environmental factors such as dust, humidity, steam, etc.

Dark on: Output energized when light is not detected by the receiving element. For through-beam sensors, light from the projector is not detected by the receiver when an object is present. For reflected light sensors, light is not detected when it is not reflected from an object surface.

Diffuse-reflected light sensors: Sensors that detect all scattered and re-reflected light. Light reflected from nearby surfaces, as well as the intended object surface, is detected. Diffuse-reflected light sensors are often called “proximity switches,” since they switch when any object is near. Also use to detect color contrast when colors reflect light intensity differently (green LED recommended for this application).

EEPROM: Acronym which stands for electronically erasable, programmable, read only memory.

Excess gain: Ratio of optical power available at a given projector-to-receiver range divided by the minimum optical power required to trigger the receiver.

Extraneous light: Incident light received by a sensor, not related to the presence or absence of an object being detected. Extraneous light is usually unwanted background light such as sunlight and incandescent lamps in close proximity.

ΔE : The measurement of color difference as a three-variable function, located on an XYZ axis of light, hue, and chroma values.

Hysteresis: The lag in response shown by an object in reacting to changes in the forces affecting it. Operating point and release point at different levels. For solid state sensors, this is accomplished electrically. For mechanical switches, it results from storing potential energy before the transition occurs.

Light on: Output energized when light is detected by the receiving element. For through-beam sensors, light from the projector is detected by the receiver when an object is not present. For reflected light sensors, light is detected when it is reflected from an object's surface.

Linearity: The measure of the extent to which a certain response is directly proportional to the applied excitation.

NPN/PNP: Types of open collector transistors. NPN is a sink transistor; output on establishes negative potential difference. PNP is a source transistor; output on establishes positive potential difference.

Polarizing: Filtering out all reflected light except that which is projected in one plane only. Polarized retro-reflected light sensors detect the light from corner-cube type reflectors when an object is not present.

Reflected-light sensors: Sensors with the projector and receiver in one housing. Light is projected by the light source, and reflected light is received by the optical surface. Includes diffuse-reflected, retro-reflected, limited-reflected, and spot-reflected sensors.

Repeatability: Ability of a sensor to reproduce output readings consistently when the same value is applied consecutively, in the same direction, for a specified number of cycles, or for a specified time duration.

Resolution: Overall dimension of the smallest object which can be detected (when sensing the presence of an object) or smallest increment of distance which can be distinguished with reliable results (when sensing the position of an object).

Response time: Time elapsed between input and output. Total response time is the sum of object detection, amplifier response, and output response times.

Retro-reflective: This type of reflected light sensor uses a special reflector to return projected light when an object is not present. Sensor detects the presence of an object when the light is reflected differently.

Through-beam sensors: Sensors with a separate projector and receiver. The light source from the projector is detected by the receiver, except when an object is present.

Transient: Undesirable surge of current (many times larger than normal current) for a very short period, such as during the start-up of an inductive motor.