

## Operator Interface Touchscreen Family

### Smart design to fit your needs

From the large 12.1" TFT LCD Screen, to the compact 4.6" STN LCD, our screens support either monochrome or 256 colors with high pixel resolution to give you sharp images and excellent visibility. In keeping with IDEC's attention to detail, our slim-body design adapts to applications where space is limited. With up to 8MB of memory and a 200MHz 32-bit RISC CPU, IDEC Touchscreens put control, power and speed at your fingertips.

### Versatile, High functionality

IDEC Touchscreens can function as either a stand alone controller or communicate with IDEC PLCs and a wide array of major manufacturers' PLCs. Touchscreens interface with any of your equipment to provide graphical data presentations in vivid color and to display bar graphs and meters to represent analog data. Illuminated pushbuttons can replace physical mechanical switches; pilot lamps can display on/off states and show almost any production information you need to monitor.

### Programming power made easy

IDEC's powerful WindO/I-NV2 software lets you create colorful graphical interfaces for easier production supervision and control. A built-in library of over 5000 bitmap images helps you easily display almost every manufacturing activity you want to control. Our programming software is intuitive and user-friendly. With re-sizeable pop-up screens, Windows compatible fonts, and multilingual text capabilities, you enjoy the utmost flexibility in designing and programming.

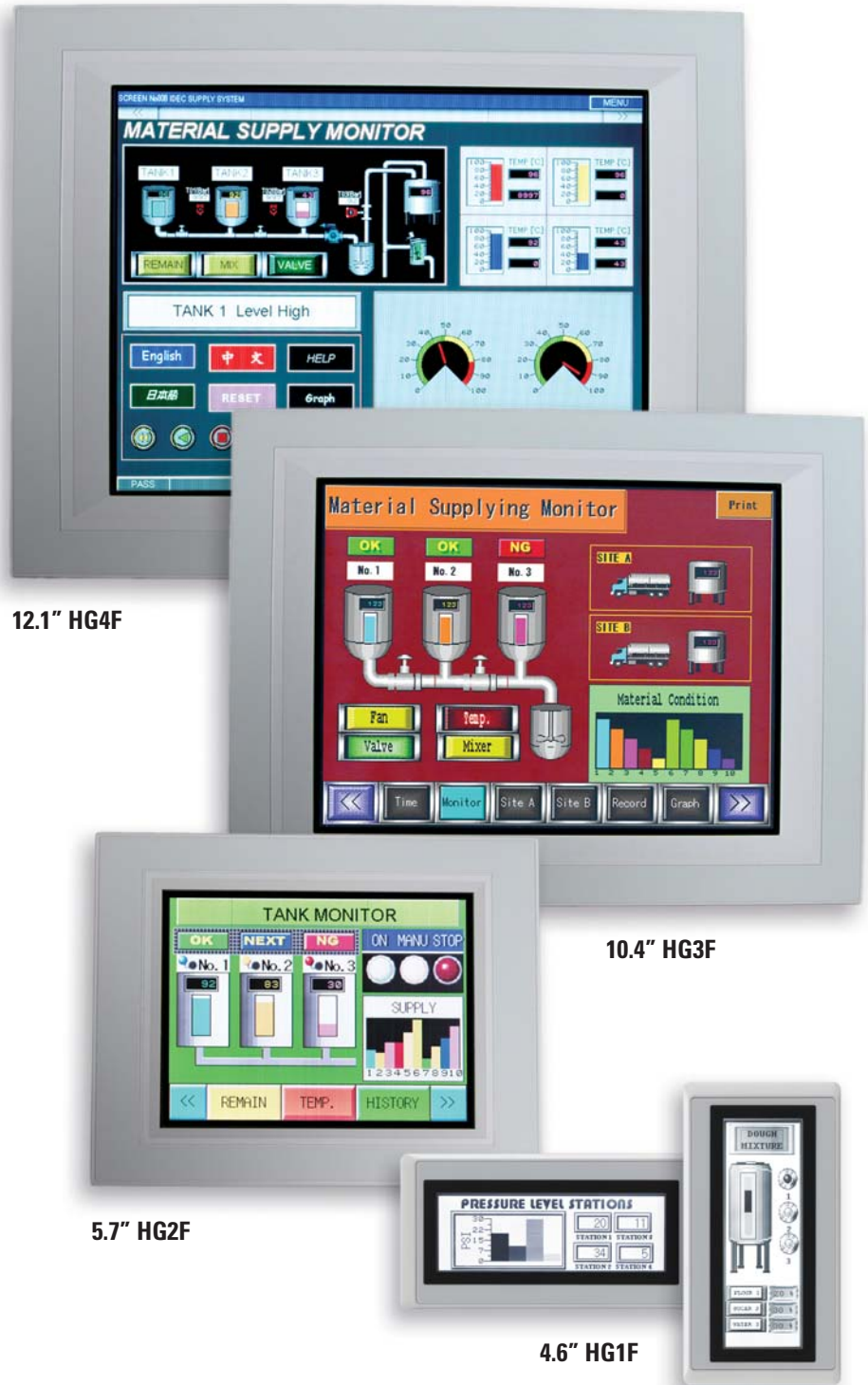

12.1" HG4F

10.4" HG3F

5.7" HG2F

4.6" HG1F



PLCs

Operator Interfaces

Automation Software

Power Supplies

Sensors

Communication & Networking

## Features

The OI Touchscreen Family is ideally matched to today's sophisticated technology. Using a wide range of graphical options, you can represent specific equipment, make production information immediately apparent and instantly display safety problems. Consolidating controls on an IDEC touchscreen eliminates costly investments in wiring and installation of multiple pushbutton indicators on a traditional control panel. Just think how you can benefit with touchscreens.



### Expansion I/O

An expansion digital I/O module gives you the option of expanding your system with 16 DC inputs and 16 transistor outputs for basic PLC control (excluding 4.6" HG1F touchscreen).



### Basic Data Representation

A built-in software library of over 5000 bit-mapped images lets you graphically represent almost any plant activity or equipment that you want to monitor or control. In addition to representing meters, bar graphs and switches, you can also incorporate keypads to facilitate changing values. Our user-friendly programming software lets you design each screen by simply selecting objects from a pull-down menu or from a row of object icons and dropping it onto the screen work area. All bitmap images are available in 256 colors and are easily re-configurable.

### Ethernet Support

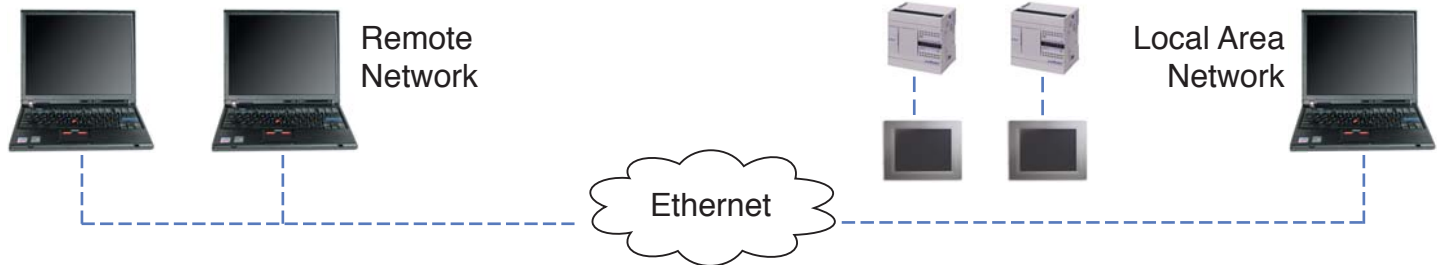

The built-in 10BaseT Ethernet port found on the 10.4" and 12.1" touchscreens allow communications with PLCs using Ethernet/IP, Modbus TCP/IP or IDEC networking protocol. The touchscreens also allow you to remotely monitor machine-operating status via the Internet or your Local Area Network using any web browser. Regardless of your location, you can use your PC's browser (Netscape or Internet Explorer) to collect data about any touchscreen project. You can efficiently monitor and manage production activity from your office without the time or expense of travel.

### Recipe, Alarm and Trend Logging

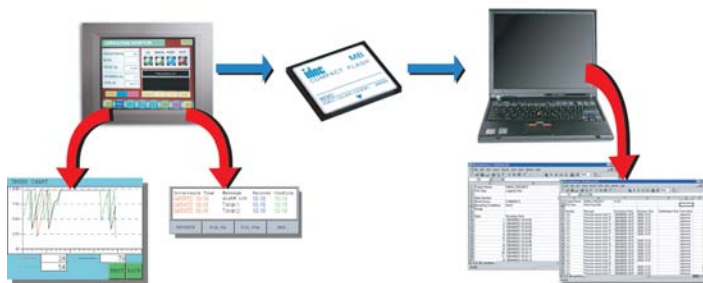

The Recipe function allows you to conveniently set operational parameters, which can be individually defined for different processes. The Alarm function stores historical events with a date and time stamp compliant to the ISA (Instrument Society of America) Standards, adding additional options to display and manage alarm messages. Trend Logging expresses data in graphical form according to the time period you define. Using these functions, you can quickly view production information and collect and manage data.

### Compact Flash Card



OI Touchscreens (excluding 4.6" HG1F) support Compact Flash (CF) Cards with up to 512 MB of memory. In addition to storing recipe, alarm and trending data, the CF Card can also store screen captures in a BMP format for documentation purposes. The CF Card can hold one or more projects and you can easily transfer a project directly to another touchscreen by simply inserting the card into the second touchscreen and downloading what you need.

Features, con't



To meet your application needs, IDEC offers 12.1" and 10.4" TFT LCD screens, and 4.6" and 5.7" STN LCD screens that come with 256 colors or in monochrome to provide you with either multicolored or gray scale graphics. All screens have high pixel resolution and super bright LCD screens with 400 cd/m<sup>2</sup> for the 12.1", 450 cd/m<sup>2</sup> for the 10.4" screen, 250 cd/m<sup>2</sup> for the 5.7" and 500 cd/m<sup>2</sup> for the 4.6" screen to provide sharp quality images, with RS-232 / RS-485 / RS-422 communication. In addition, all IDEC

Touchscreens communicate with IDEC as well as many other industry leading PLC manufacturers.

Their slim body style of: 35.3mm depth for the 4.6" HG1F, 50mm depth for the 5.7" HG2F, 49.6mm depth for the 10.4" HG3F, and 52.1mm depth for the 12.1" HG4F, provide an advantage in space in a panel.



OI Link Communication



This permits a single PLC to communicate with multiple IDEC touchscreens, where one touchscreen serves as the master and up to 15 as slaves. An OI Link will accommodate communications over a maximum distance of 200 meters. The OI Link should be used whenever you are using more than one touchscreen in a location to monitor and control a single PLC.

1:N PLC Communication



This mode allows a single IDEC touchscreen to communicate with multiple PLCs. It is used when you need only one centrally located touchscreen to monitor and control PLCs in different locations. Depending on the PLC type, a maximum of 31 PLCs can be connected to one touchscreen. PLC manufacturers supported for 1:N communication are: IDEC OpenNet Controller and MicroSmart family, Automation Direct (Koyo): DirectLogic-DL205/405 and Modicon: Modbus RTU.

Pass Thru Function

This function lets you download a PLC program from a PC through the touchscreen without interrupting operations. Only one cable is needed to program both units. The Pass Thru communications function is applicable to the following PLCs: IDEC OpenNet Controller and MicroSmart family, and Mitsubishi MELSEC-FX, FX3UC and Q.

Support of Leading Manufacturer's PLCs

IDEC Touchscreen communications capabilities expand well beyond IDEC brand PLCs. Other major PLC manufacturers supported are: Allen Bradley, Mitsubishi, Omron, Automation Direct (Koyo), Keyence, GE, Modicon, Siemens, Sharp, Hitachi, Schneider, Yaskawa, Fanuc, Matsushita Electric Works (Panasonic) and Yokogawa.

The 10.4" and 12.1" IDEC Touchscreens can remotely communicate with multiple devices or PLCs over an Ethernet network, using Ethernet/IP, Modbus TCP/IP, or IDEC 1:N drivers. Only one centrally located IDEC touchscreen is necessary to communicate with up to 16 PLCs that are located in different locations. The Ethernet/IP driver supports the following Allen Bradley Series PLCs: Micrologix, SLC500, PLC5 and ControlLogix.

Approvals and International Ratings

The OI Touchscreen Family is UL listed for use in hazardous locations (Class I Div. 2). In addition the 4.6" and 5.7" screens are IP65 and Nema Type 13 rated, while the 10.4" and 12.1" screens are IP66, Nema Type 4, 4X, 13 rated so they can be used in the most demanding industrial applications.



Printer Function



Use this capability to print alarm data so a hard-copy record of specific events can be maintained. Copies of screens can also be printed when needed for documentation. Serial printers are supported on all OI Touchscreens, while Parallel Printers are supported on 10.4" and 12.1" models.

Barcode Reader Support

IDEC Touchscreens provide a serial port that you can configure for use by special communication devices such as barcode readers. A barcode reader can send data directly to the touchscreen, where it can be used for quick viewing before being transferred to the PLC for further data manipulation.



Debugging Functions

Two modes are available for either monitoring data or troubleshooting. Once you download the project you created in WindO/I-INV2 to the touchscreen, you can use the Debugging Mode to communicate directly with the touchscreen and switch between screens or view and modify batch data from the controls of your PC. In Simulation Mode, you can use simple On/Off control without connecting to the PLC.

PLCs

Operator Interfaces

Automation Software

Power Supplies

Sensors

Communication & Networking

## WindO/I-NV2 Programming Software

### Easy Programming: Intuitive Drag & Drop Functionality

The WindO/I-NV2 software for all OI Touchscreens is the programming tool that lets you create colorful graphical interfaces to visualize operating conditions. The software is very intuitive with drag and drop functionality. The Help menus are a great source of information and a built-in library of bitmaps provides over 5000 images to help expand your creativity. The software also includes a debug function where you can go online with the touchscreen for monitoring and changing data.

### Flexible Screen Display for Efficient Editing

With WindO/I-NV2 software, screens can be easily arranged. A total of 3000 base screens can be created (as allowed by the memory size). Sub-screens known as pop-up menus can be resized, made (showing backgrounds) using the superimpose function, and can be made to appear anywhere inside the base screen.

### Easy to manage Projects and Screens

#### Screens and Project Settings List:

- Screens can be duplicated and their properties can be changed easily.
- Project settings can be edited.
- Devices, text, and images can be imported or exported.

#### Screen Preview List:

- Screens can easily be selected using the preview image function.

#### Object List:

- Each object displays its properties such as; type of device used, conditions and operations.

#### Buttons:

- A button selected from an object list is shown on the editing screen.

### Extensive Image Library



A built-in symbol library provides over 5000 symbols to help you create cutting-edge graphical screens. Image data from BMP, JPG, DXF, WMF, and ICO files can also be imported.



No.	Name	Type	Device	Trigger Type	Trigger Condition
55	Rectangle	Rectangle			
56	Bitmap	Bitmap			
57	Rectangle	Rectangle			
58	Rectangle	Rectangle			
59	Line	Line			
60	WordCommand13	Word Write	LDR 70	1: Falling-edge	[LSM 2]
61	WordCommand10	Word Write	LDR 67	2: Satisfy the c...	[D 6] == 5 & 3
62	BarGraph4	Bar Graph	LDR 71		
63	BarGraph5	Bar Graph	LDR 72		
64	BarGraph6	Bar Graph	LDR 75		
65	NumDisplay1	Numerical	LDR 71		
66	NumDisplay2	Numerical	LDR 73		
67	NumDisplay3	Numerical	LDR 67		
68	NumDisplay1	Numerical	LDR 75		
69	BitSwitch3	Bit Button	LM 10	3: Always ON	
70	BitSwitch4	Bit Button	LM 10	3: Always ON	
71	BitSwitch5	Bit Button	LM 1	3: Always ON	
72	BitSwitch6	Bit Button	LM 2	3: Always ON	
73	Lamp2	Pilot Lamp	LX 0	6: While safety...	[O 150] >= [D
74	BitSwitch7	Bit Button	LM 3	3: Always ON	
75	ScreenSwitch1	Goto Screen	10	3: Always ON	
76	WordCommand1	Word Write	LDR 71	6: While safety...	0 == [LDR 71]
77	WordCommand55	Word Write	LDR 73	0: Rising-edge	[LSD 11-0]
78	WordCommand55	Word Write	LDR 73	6: While safety...	20 >= [LDR 73]
79	WordCommand11	Word Write	LDR 68	2: Satisfy the c...	100 == [LDR 68]
80	NumDisplay2	Numerical	LDR 73		
81	NumDisplay2	Numerical	LDR 73		
82	NumDisplay2	Numerical	LDR 73		
83	BarGraph1	Bar Graph	LDR 58		
84	BarGraph1	Bar Graph	LDR 58		
85	NumDisplay3	Numerical	LDR 67		
86	NumDisplay2	Numerical	LDR 67		



WindO/I-NV2 Software, con't

Compatible with Standard Windows™ Fonts

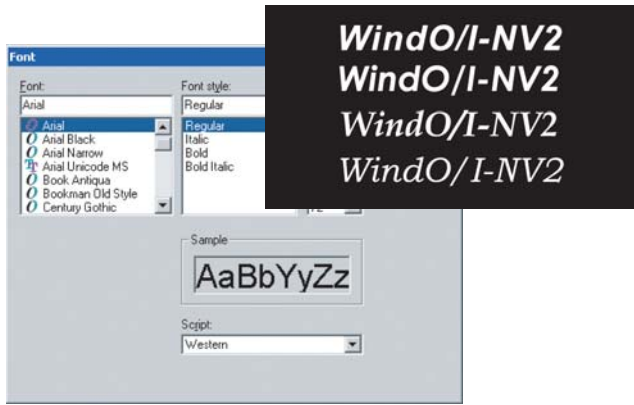

Fonts used in Windows™ can be used on the OI Touchscreens, making it possible to choose from a variety of text styles.

Easy Programming of Operating Conditions

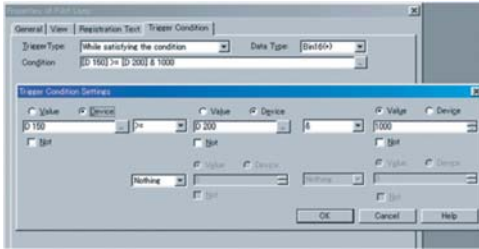

- Operating conditions for objects such as switches, lamps, bit/word write, screen switching, and many more are easy to use. Step by step wizards guide the user through the set-up process.

Create Recipes to set parameters for different processes

- Upload or download parameters to and from the PLC
- 1,024 available channels; store up to 8,000 parameters per channel

Set up Alarm Log function for messages and alerts

- Monitors alarm conditions from a PLC and stores historical events with a date and time stamp
- Meets ISA standards for visual alarm management
- Select size and contrast of alarm message and status
- Scroll a list of alarm messages

Create Trend Graphs to monitor critical data points

- Quickly view production information
- Collect and manage data
- Up to 16 channels in a graph

Multilingual Capabilities for Worldwide Applications



- The OI Touchscreen family can support other languages. With the text group function you can create a text database in different languages. Once the touchscreen is in a different country (e.g. China or Mexico) the customer can easily switch all text messages from English to Chinese or Spanish by a touch of a button.
- Windows 2000, Vista and XP make it possible to input Japanese, Simplified Chinese, Traditional Chinese, and Korean languages. Western European languages (English, German, French, Italian, Spanish, Dutch, Norwegian, Danish, Finnish, Swedish, etc.) Central European languages (Czech, Hungarian, Romanian, Croatian, Slovene, Polish, and Slavic), Baltic languages, Cyrillic languages (Russian, Ukrainian, Bulgarian, Macedonian).

Script function

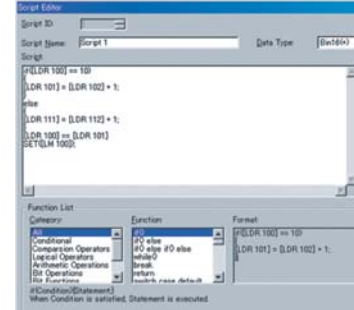

- Users with programming knowledge in C can combine conditional statements, mathematical operations and other functions to create simple and complex processes.
- Greatly reduce the programming required in the PLC.
- A syntax check function is also available to provide easy program troubleshooting.

Security function

- Provides different levels of security and restrictions for multiple users on editing projects or displaying screens and objects.

Available Functions

PLCs  
Operator Interfaces  
Automation Software  
Power Supplies  
Sensors  
Communication & Networking

Category	Item	HG1F	HG2F		HG3F	HG4F
			Standard	CC Switch Option		
<b>Communication</b>	PLC link communication	√	√	√	√	√
	DM link communication	√	√	√	√	√
	OI link communication	√	√	√	√	√
	Ethernet	—	—	—	√	√
	No host	√	√	√	√	√
<b>User Memory</b>		1 MB	2 MB	2 MB	8 MB*	8 MB*
<b>Interface</b>	RS232C/RS485 (422)	√	√	√	√	√
	Ethernet	—	—	—	√	√
	CF card slot	—	√	√	√	√
	Parallel	—	—	—	√	√
<b>Display Color</b>	256 colors	—	√	√	√	√
	Monochrome	√	√	√	—	—
<b>Brightness</b>	(cd/m <sup>2</sup> )	500	250	250	450	400
<b>Resolution</b>	(pixels)	300 x 100	320 x 240	320 x 160**	640 x 480	800 x 600
<b>Touch Switch</b>		—	16 x 12	16 x 8	32 x 24	40 x 30
<b>CC Switch</b>		—	—	4 x 1 row (bottom)	—	—
<b>Expansion Unit</b>	Digital I/O unit	—	√	√	√	√
<b>Features</b>	System program download	√	√	√	√	√
	Font download	√	√	√	√	√
	Download via Ethernet	—	—	—	√	√
	Download via OI link	√	√	√	√	√
	Project transfer via CF card	—	√	√	√	√
	Printer output	√	√	√	√	√
	Backlight replacement	√	√	√	√	√
	Environment resistance	√	√	√	√	√
	Simulation	√	√	√	√	√
	Pass through	√	√	√	√	√
<b>Functions</b>	Device monitor	√	√	√	√	√
	Web server function	—	—	—	√	√
	Overlapped screens	√	√	√	√	√
	Sub-screen superimpose	√	√	√	√	√
	Text group switching	√	√	√	√	√
	Script	√	√	√	√	√
	Part operating condition setting	√	√	√	√	√
	Alarm log	√	√	√	√	√
	Logging	√	√	√	√	√
	Recipe	√	√	√	√	√
Password setting	√	√	√	√	√	
<b>Parts</b>	Bit button	√	√	√	√	√
	Word button	√	√	√	√	√
	Goto screen button	√	√	√	√	√
	Print button	√	√	√	√	√
	Key button	√	√	√	√	√
	Keypad	√	√	√	√	√
	Selector switch	√	√	√	√	√
	Potentiometer	√	√	√	√	√
	Numerical input	√	√	√	√	√
	Character input	√	√	√	√	√
	Pilot lamp	√	√	√	√	√
	Picture display	√	√	√	√	√
	Message display	√	√	√	√	√
	Message switching display	√	√	√	√	√
	Alarm list display	√	√	√	√	√
	Alarm log display	√	√	√	√	√
	Numerical display	√	√	√	√	√
	Bar graph	√	√	√	√	√
	Trend chart	√	√	√	√	√
	Pie chart	√	√	√	√	√
Meter	√	√	√	√	√	
Calendar	√	√	√	√	√	
<b>WindO/I-NV2 Functions</b>	Bit write command	√	√	√	√	√
	Word write command	√	√	√	√	√
	Goto screen command	√	√	√	√	√
	Timer	√	√	√	√	√
	Print command	√	√	√	√	√
	Screen print command	√	√	√	√	√
	Debugging	√	√	√	√	√
	Log data upload tool	√	√	√	√	√
	Graphic library tool	√	√	√	√	√
	Screen import	√	√	√	√	√
	Text browser	√	√	√	√	√
	Device browser	√	√	√	√	√
	Script browser	√	√	√	√	√
	Picture browser	√	√	√	√	√
	Basic/advanced mode	√	√	√	√	√
Preview	√	√	√	√	√	
Windows font	√	√	√	√	√	
Library function	√	√	√	√	√	
Global replace	√	√	√	√	√	
Work space	√	√	√	√	√	

\*2MB used for OS

\*\*four tactile push regions (40 x 70 pixels)

Part Numbers

OI Touchscreen

	Part Numbers	Bezel Color	Description
12.1"	HG4F-JT22TFW	Light Gray	Color TFT LCD Touchscreen
	HG4F-JT22TFB	Black*	Color TFT LCD Touchscreen
	HG4F-JT22TFW-DH485-500	Light Gray	Color TFT LCD Touchscreen with DF1 / DH485 converter/cable package for SLC 500 (w/RJ45 connector)
10.4"	HG3F-FT22TFW	Light Gray	Color TFT LCD Touchscreen
	HG3F-FT22TFB	Black*	Color TFT LCD Touchscreen
	HG3F-FT22TFW-DH485-500	Light Gray	Color TFT LCD Touchscreen with DF1/DH485 converter/cable package for SLC 500 (w/RJ45 connector)
5.7"*	HG2F-SS22VCF	Light Gray	Color STN LCD Touchscreen
	HG2F-SB22VCF	Light Gray	Monochrome STN LCD Touchscreen
	HG2F-SS22VCF-DH485-500	Light Gray	Color STN LCD Display with DF1 / DH485 converter/ cable package for SLC500 (w/RJ45 connector)
	HG2F-SB22VCF-DH485-500	Light Gray	Monochrome STN LCD Display with DF1 / DH485 converter / cable package for SLC500 (w/RJ45 connector)
5.7" with CC Click	HG2F-SS52VCF	Light Gray	Color STN LCD Touchscreen w/ CC Click Tactile Touchbutton Technology
	HG2F-SB52VCF	Light Gray	Monochrome STN LCD Touchscreen w/ CC Click Tactile Touchbutton Technology
4.6"	HG1F-SB22BF-W	Light Gray	Monochrome STN LCD Touchscreen, RS-232 comm.
	HG1F-SB22BF-B	Black	Monochrome STN LCD Touchscreen, RS-232 comm.
	HG1F-SB22YF-W	Light Gray	Monochrome STN LCD Touchscreen, RS-485/RS-422 comm.
	HG1F-SB22YF-B	Black	Monochrome STN LCD Touchscreen, RS-485/RS-422 comm.



\*Black bezel models available upon request.

Accessories

Accessories

Accessory	Description	Part Number
Programming Tools	WindQ/I-NV2 Programming software for all IDEC Touchscreen Series	HG9Y-ZSS2W
	Cable connecting PC to Touchscreen via RS-232 Serial Port	HG9Z-XCM1A
Converters	USB to RS-232 Converter for PCs without Serial Ports	FC4A-USB
	AB SLC500 (w/RJ45 connector) DF1 / DH485 Communication Package for HG2F/3F/4F	HG9Z-GWDF1DH485-3
	AB SLC500 (w/RJ45 connector) DF1 / DH485 Communication Package for 4.6" HG1F	HG9Z-GWDF1DH485-4
Protective Sheet	For 12.1" HG4F (minimum order quantity is 2 pcs.)	HG9Z-4DAP
	For 10.4" HG3F (minimum order quantity is 2 pcs.)	HG9Z-3DAP
	For 5.7" HG2F (minimum order quantity is 5 pcs.)	HG9Z-2D2
	For 4.6" HG1F (minimum order quantity is 5 pcs.)	HG9Z-1D
Mounting Clips	For 10.4" HG3F & 12.1" HG4F (minimum order quantity is 10 pcs.)	HG9Z-4K1
	For 5.7" HG2F (minimum order quantity is 4 pcs.)	HG9Z-2K1
	For 4.6" HG1F (minimum order quantity is 10 pcs.)	SLD-K02
Replacement Backlight	For 12.1" HG4F	HG9Z-4FB
	For 10.4" HG3F	HG9Z-3FB2
	For 5.7" HG2F	HG9Z-2B1
	For 4.6" HG1F	HG9Z-1FB
OI Link Unit	For all OI touchscreens	HG9Z-2G1
32 Point Digital I/O	For 10.4" HG3F & 12.1" HG4F (16 Inputs & 16 Outputs)	HG9Z-3P102
	For 5.7" HG2F (16 Inputs & 16 Outputs)	HG9Z-2P101
Compact Flash Card	128MB CF Card for 5.7" HG2F, 10.4" HG3F, 12.1" HG4F	HG9Z-MF128
Replacement Battery	Lithium Battery for 4.6" HG1F	HG9Z-XR1

**Cables**

Manufacturer	Series	Applicable CPU	Communication Type	Communication Module Required	HG1F Comm. Cable P/N	HG2F/3F/4F Comm. Cable P/N	
IDEC	FA-3S	PF3S-CP12/CP13	RS232	PF2-CLA	Contact IDEC*	Contact IDEC*	
			RS485	PF3S-SIF2			
		RS485	PF3S-SIF4				
	FA-2J	PF2J	PF3S-CP11/CP11T	RS232	PF2-CLA		
			Micro3	FC2A	RS485	Built-in Port	HG9Z-1C121A
	Micro3C	FC2A-%C	RS232	Built-in Port	HG9Z-XC183	HG9Z-3C125A	
			RS485	Built-in Port	HG9Z-1C131A	HG9Z-2C145A	
	OpenNet	FC3A	RS232	Built-in Port	HG9Z-XC183	HG9Z-3C125A	
			RS485	Built-in Port	HG9Z-1C131A	HG9Z-2C145A	
			Ethernet	FC4A-SX5ES1E	Not Supported	CAT 5 Ethernet Crossover cable	
MicroSmart/Pentra MicroSmart	FC4A, FC5A	RS232	Built-in Port	FC4A-KC1CA	FC4A-KC2CA		
			FC4A-PC1/HPC1	HG9Z-XC183 or FC4A-KC1CA			
		RS485	FC4A-PC2/HPC2	HG9Z-1C121A	HG9Z-3C115A		
			FC4A-PC3/HPC3	HG9Z-1C131A	HG9Z-2C145A		
Ethernet	FC4A-SX5ES1E	Not Supported	CAT 5 Ethernet Crossover cable				
Allen Bradley	PLC-5	1785	RS232	Built-in Port	Contact IDEC*	Contact IDEC*	
				1770-KF2			
			RS422	Built-in Port			
	1770-KF2						
Ethernet	1785-ENET	Not Supported	CAT 5 Ethernet Crossover cable				
PLC-5E	1785	Ethernet	Built-in Port	Not Supported	CAT 5 Ethernet Crossover cable		
SLC-5/03, SLC-5/04, SLC5/05	1747-L53, 1747-L54, 1747-L55	DH485	Built-in Port	please purchase IDEC converter: HG9Z-GWDF1DH485-4 (DF1-DH485 converter)	please purchase IDEC converter: HG9Z-GWDF1DH485-3 (DF1-DH485 converter)		
				Ethernet	1761-NET-ENI	Not Supported	CAT 5 Ethernet Crossover cable
		Ethernet	1747-L55	Ethernet	Built-in Port	Not Supported	CAT 5 Ethernet Crossover cable
MicroLogix 1000, 1100, 1200, 1500	1761, 1762, 1763, 1764	RS232	Built-in Port	HG9Z-XC500	HG9Z-2C135A		
				Ethernet	1761-NET-ENI	Not Supported	CAT 5 Ethernet Crossover cable
MicroLogix 1100	1763	Ethernet	Built-in Port	Not Supported	CAT 5 Ethernet Crossover cable		
ControlLogix	1756	RS232	Built-in Port	Contact IDEC*	Contact IDEC*		
				Ethernet	1756-ENBT	Not Supported	CAT 5 Ethernet Crossover cable
CompactLogix	1768, 1769	RS232	Built-in Port	Contact IDEC*	Contact IDEC*		
				Ethernet	Built-in Port	Not Supported	CAT 5 Ethernet Crossover cable
FlexLogix	1794-L33, 1794-L34	RS232	Built-in Port	Contact IDEC*	Contact IDEC*		

1. \* Consult IDEC for wiring schematic and cable.  
 2. Visit [www.idec.com/oi](http://www.idec.com/oi) for the most up-to-date list of cables.

Cables

Manufacturer	Series	Applicable CPU	Communication Type	Communication Module Required	HG1F Comm. Cable P/N	HG2F/3F/4F Comm. Cable P/N	
Automation Direct (Koyo)	Direct Logic 05	DL05	Ethernet	D0-ECOM/D0-ECOM100	Not Supported	CAT 5 Ethernet Crossover cable	
	Direct Logic 06	DL06	Ethernet	D0-ECOM/D0-ECOM100	Not Supported	CAT 5 Ethernet Crossover cable	
	Direct Logic 205	D2-240, D2-250, D2-250-1, D2-260	Ethernet	Built-in Port	HG9Z-XC400	Contact IDEC*	
				D2-ECOM	Not Supported	CAT 5 Ethernet Crossover cable	
				D2-ECOM-F			
	Direct Logic 405	D4-430, D4-440	RS232	Built-in Port	Contact IDEC*	Contact IDEC*	
				D4-DCM			
		D4-430, D4-440, D4-450	Ethernet	RS422	Built-in Port	Not Supported	CAT 5 Ethernet Crossover cable
				D4-ECOM			
	Siemens	S7-200	CPU 212, 214, 215, 216, 221, 222, 224, 224XP, 226, 226XM	RS485	Built-in Port	Contact IDEC*	HG9Z-2C155A
S7-300		CPU 313, 314, 315, 315-2DP, 316, 318	RS232	CP-340-RS232C or CP-341-RS232C	Contact IDEC*	Contact IDEC*	
S7-400		CPU 412, 414, 416, 416F-2, 417	RS485	CP-340-RS 422/485 or CP-341-RS 422/485			
			RS485	CP-440-RS 422/485 or CP-441-RS 422/485			
	RS232		CP-440-RS232C or CP-441-RS232C				
Schneider (Telemecanique, SquareD)	Twido	TWDLCA10DRF	RS485	Built-in Port	HG9Z-1C121A	HG9Z-3C115A	
			RS485	Built-in Port	HG9Z-1C121A	HG9Z-3C115A	
			RS232	TWD NAC 232D	HG9Z-XC183	HG9Z-3C125A	
			RS485	TWDNAC485D	HG9Z-1C121A	HG9Z-3C115A	
		TWDLCA*DRF (*16,24,40 CPUs)	RS485	TWDNAC485T	HG9Z-1C131A	HG9Z-2C145A	
			RS485	Built-in Port	HG9Z-1C121A	HG9Z-3C115A	
			RS232	TWDNOZ232D	HG9Z-XC183	HG9Z-3C125A	
			RS485	TWDNOZ485D	HG9Z-1C121A	HG9Z-3C115A	
		TWDLMDA*DTK/DUK/DRT (* 20 & 40 CPUs)	RS485	TWDNOZ485T or TWDX-CPODM+ TWDNAC485T	HG9Z-1C131A	HG9Z-2C145A	
			RS485	TWDXCPODM + TWD-NAC485D	HG9Z-XC183	HG9Z-3C125A	
			RS232	TWDXCPODM + TWD-NAC232D	HG9Z-1C121A	HG9Z-3C115A	
			Momentum	171CCC96020	RJ-45 Ethernet Port	Built-in RJ-45 Port	Not Supported
Others	Others	Any PLCs that support MOD-BUS/TCP protocol	RJ-45 Ethernet Port	Built-in RJ-45 Port	Not Supported	CAT 5 Ethernet Crossover cable	
Panasonic (Aromat)	FP	FP0	RS232	Built-in-Port	HG9Z-XC300	HG9Z-2C165A	
			RS232	Built-in-Port	Contact IDEC*	Contact IDEC*	
		FP1	RS232	AFP8550			
			RS422	Built-in-Port			

PLCs

Operator Interfaces

Automation Software

Power Supplies

Sensors

Communication & Networking

1. \* Consult IDEC for wiring schematic and cable.  
2. Visit [www.idec.com/oi](http://www.idec.com/oi) for the most up-to-date list of cables.

**Cables**

Manufacturer	Series	Applicable CPU	Communication Type	Communication Module Required	HG1F Comm. Cable P/N	HG2F/3F/4F Comm. Cable P/N						
Panasonic (Aromat) con't	FP	FP Sigma	RS232	Built-in-Port	Contact IDEC*	HG9Z-2C165A						
				FPG-COM1 (AFPG801)		Contact IDEC*						
				FPG-COM2 (AFPG802)			Contact IDEC*					
		FP10, FP10SH	RS485	FPG-COM3 (AFPG803)				Contact IDEC*				
				FP2, FP2SH					RS232	Built-in-Port	Contact IDEC*	
										AFP3462		Contact IDEC*
FP2, FP2SH	RS232	Built-in-Port	Contact IDEC*									
		AFP3462		Contact IDEC*								
Mitsubishi	MELSEC-A	A1N, A2N, A3N			RS232	AJ71C24-S3/S6/S8 or AJ71UC24	HG9Z-XC145		HG9Z-3C135A			
					RS485	AJ71C24-S3/S6/S8 or AJ71UC24	Contact IDEC*	Contact IDEC*				
		A1SH			RS485	A1SJ71C24-R2/R4 or A1SJ71UC24-R2/R4	Contact IDEC*	Contact IDEC*				
					RS232	A1SJ71C24-R2/R4 or A1SJ71UC24-R2/R4	HG9Z-XC203	HG9Z-3C145A				
		A2CCPUC24	RS232		Built-in-Port	HG9Z-XC203						
		A0J2, A0J2H	RS232	A0J2-C214-S1	HG9Z-XC145	HG9Z-3C135A						
			RS485	A0J2-C214-S1	Contact IDEC*	Contact IDEC*						
		A2A, A3A, A2U, A3U, A4U	RS485	AJ71C24-S6/S8 or AJ71UC24	Contact IDEC*	Contact IDEC*						
			RS232	AJ71C24-S6/S8 or AJ71UC24	HG9Z-XC145	HG9Z-3C135A						
		A2US, A2USH-S1	RS232	A1SJ71C24-R2/R4 or A1SJ71UC24-R2/R4	HG9Z-XC203	HG9Z-3C145A						
			RS485	A1SJ71C24-R2/R4 or A1SJ71UC24-R2/R4	Contact IDEC*	Contact IDEC*						
		A2N A1SJH, A1SH, A2SH, A2C, A0J2H A2A, A3A, A2US, A2USH A2U, A2USH-S1	RS422	Built-in-Port	HG9Z-XC255	HG9Z-3C165A						
							MELSEC-Q	Q00CPU, Q01CPU Q02CPU Q02CPU-A	RS232	Built-in-Port	HG9Z-XC265	Contact IDEC*
									Q02CPU, Q02HCPU, Q06HCPU, Q12PHCPU, Q25HCPU	RS232	QJ71C24, QJ71C24N QJ71C24N-R2	HG9Z-XC203
RS485	QJ71C24, QJ71C24N QJ71C24N-R2									Contact IDEC*	Contact IDEC*	
Q00JCPU, Q00CPU, Q01CPU, Q02CPU, Q02HCPU, Q06HCPU, Q12H CPU, Q25HCPU	Ethernet	QJ71E71-100 QJ71E71-B5 QJ71E71-B2"	Not Supported	CAT 5 Ethernet Crossover cable								
MELSEC-QnA	Q4ACPU, Q4ARCPU, Q3ACPU, Q2ACPU-S1, Q2ACPU	RS232	RS232	AJ71QC24N-R2	HG9Z-XC145	HG9Z-3C135A						
			RS485	AJ71QC24N, AJ71QC24N-R4	Contact IDEC*	Contact IDEC*						
		Ethernet	Ethernet	AJ71QE71N3-T	Not Supported	CAT 5 Ethernet Crossover cable						
			Ethernet	AJ71QE71N-B2	Not Supported	CAT 5 Ethernet Crossover cable						
			Ethernet	AJ71QE71N-B5	Not Supported	CAT 5 Ethernet Crossover cable						

1. \* Consult IDEC for wiring schematic and cable.  
2. Visit [www.idec.com/oi](http://www.idec.com/oi) for the most up-to-date list of cables.

Cables

Manufacturer	Series	Applicable CPU	Communication Type	Communication Module Required	HG1F Comm. Cable P/N	HG2F/3F/4F Comm. Cable P/N		
Mitsubishi, continued	MELSEC-FX	Q2ASH CPU-S1, Q2ASHCPU, Q2ASCPU-S1, Q2ASCPU	RS232	A1SJ71QC24N-R2	HG9Z-XC203	HG9Z-3C145		
			RS485	A1SJ71QC24N	Contact IDEC*	Contact IDEC*		
			Ethernet	A1SJ71QE71N3-T	Not Supported	CAT 5 Ethernet Cross-over cable		
			Ethernet	A1SJ71QE71N-B2	Not Supported	CAT 5 Ethernet Cross-over cable		
			Ethernet	A1SJ71QE71N-B5	Not Supported	CAT 5 Ethernet Cross-over cable		
		FX1,FX2,FX2C	RS422	Built-in Port	HG9Z-XC255	HG9Z-3C165A		
		FX0,FX0N,FX2N,FX2NC,FX3UC,FX3U	RS422	Built-in Port w/ cable FX-20P-CADP	HG9Z-XC255	HG9Z-3C165A		
		FX0,FX0N,FX2N,FX2NC,FX3UC,FX3U	RS422	Built-in Port	HG9Z-XC245	Contact IDEC*		
		FX2N	RS232	FX2N-232-BD	Contact IDEC*	Contact IDEC*		
			RS422	FX2N-422-BD and FX-20P-CADP	HG9Z-XC255	HG9Z-3C165A		
				FX2N-422-BD	HG9Z-XC245	Contact IDEC*		
		FX1N	RS232	FX1N-232-BD	Contact IDEC*	Contact IDEC*		
			RS422	FX1N-422-BD and FX-20P-CADP	HG9Z-XC255	HG9Z-3C165A		
				FX1N-422-BD	HG9Z-XC245	Contact IDEC*		
		FX3UC, FX3U	RS422	Built-in Port	HG9Z-XC255	HG9Z-3C165A		
			RS232	FX3U-232ADP	Contact IDEC*	Contact IDEC*		
				FX3U-232-BD	Contact IDEC*	Contact IDEC*		
		Omron	SYSMAC-C	CPM1, CPM1A	RS232	CPM1-CIF01	HG9Z-XC213	HG9Z-3C155A
					RS422	CPM1-CIF11	Contact IDEC*	Contact IDEC*
				CPM2A	RS232	Built-in-Port	CPM1-CIF01	HG9Z-XC213
C500, C500F, C1000H, C2000, C2000H	RS232			C120-LK201-V1	HG9Z-XC155	HG9Z-3C135A		
				C500-LK201-V1				
	RS422			C120-LK202-V1	Contact IDEC*	Contact IDEC*		
				C500-LK201-V1				
C1000HF	RS422			C500-LK203	HG9Z-XC155	HG9Z-3C135A		
	RS232			C500-LK203				
C200HS	RS232			C200H-LK201	HG9Z-XC155			
	RS422			C200H-LK202	Contact IDEC*	Contact IDEC*		
C200HE, C200HG, C200HX	RS422			C200HW-COM03/06	HG9Z-XC155	HG9Z-3C135A		
	RS232			C200H-LK201				
				C200HW-COM02/040/5/06			HG9Z-XC213	HG9Z-3C155A
C120, C120F	RS232			C120-LK201-V1	HG9Z-XC155	HG9Z-3C135A		
	RS422			C120-LK202-V1	Contact IDEC*	Contact IDEC*		
CQM1H, C200HS-CPU21/23/31/33	RS232			Built-in-Port	HG9Z-XC213	HG9Z-3C155A		

PLCs

Operator Interfaces

Automation Software

Power Supplies

Sensors

Communication & Networking

1. \* Consult IDEC for wiring schematic and cable.  
 2. Visit [www.idec.com/oi](http://www.idec.com/oi) for the most up-to-date list of cables.

**Cables**

Manufacturer	Series	Applicable CPU	Communication Type	Communication Module Required	HG1F Comm. Cable P/N	HG2F/3F/4F Comm. Cable P/N
PLCs Omron con't	SYSMAC-C	C200HE-CPU42, C200HG-CPU43/63, C200HX-CPU44/64	RS232	Built-in-Port	HG9Z-XC213	HG9Z-3C155A
	CS1	CS1G, CS1H	RS232	Built-in-Port		
			CS1W-SCB41 (port1)			
	RS422	CS1W-SCB41 (port2)	Contact IDEC*	Contact IDEC*		
CJ1	CJ1M, CJ1H, CJ1G	RS232	Built-in-Port	HG9Z-XC213	HG9Z-3C155A	
Operator Interfaces Keyence	Conventional KV	KV 10, 16, 24, 40, 80	RS232	Built-in-Port	Contact IDEC*	
	Visual KV	KV-10,16,24,40				
	KV-700/1000	KV-700, KV-1000	RS232/485/422	KV-L-20R		
Operator Interfaces GE Fanuc	VersaMax Nano/Micro	10 I/Os, 14 I/Os	RS232	Built-in-Port	HG9Z-XC273A	
		23 I/Os, 28 I/Os	RS485	Built-in-Port		
	Series 90-30	CPU 311, 313, 323, 331, 341, 350, 351, 352, 360, 363, 364, 374	RS485	Built-in-Port		
		CPU 331, 341, 350, 351, 352, 360, 363, 364, 374	RS232 RS485	IC693CMM311		
Automation Software SHARP	New Satellite JW	JW-21CU, JW-22CU, JW-31CUH/H1, JW-32CUH/H1, JW-33CUH/H1/H2/H3	RS485	JW-21CM	Contact IDEC*	
		JW-50CU/CUH, JW-70CU/CUH, JW-100CU/CUH	RS485	JW-10CM		
		JW-22CU, JW-70CU/CUH, JW-100CU/CUH	RS232	Built-in Port		
		JW-32CUH/H1, JW-33CUH/H1/H2/H3	RS232 RS485	Built-in Port		
Power Supplies Hitachi	S10mini	S10mini	RS485	Buit-in Port	Contact IDEC*	
			RS232	LQE160		
			RS485	LQE165		
			RS232	LQE560		
			RS485	LQE565		
	S10V	LQP510	RS232	Buit-in Port		
			RS485	LQE560		
			RS485	LQE565		
Sensors JTEKT(TOYODA)	TOYOPUC-PC2J	PC2J	RS485	Buit-in Port		
	TOYOPUC-PC3J	PC3J	RS485	Buit-in Port		
		PC3JD, PC3JG	RS485	Buit-in Port		
Sensors Toshiba Machine Works	TC200	TC3-13B1	RS232	Buit-in Port		
	TCmini	TC03-01, TC03-02	RS232	Buit-in Port		
Communication & Networking YASKAWA ELECTRIC CORPORATION	Machine Controller	MP920, MP930, MP2300	RS232	Buit-in Port		
			RS232	217IF		
Communication & Networking FANUC	Power Mate	Power Mate-MODEL D	RS422	Buit-in Port		
		16i, 160i	RS232	Buit-in Port		

1. \* Consult IDEC for wiring schematic and cable.  
2. Visit [www.idec.com/oi](http://www.idec.com/oi) for the most up-to-date list of cables.

Cables

Manufacturer	Series	Applicable CPU	Communication Type	Communication Module Required	HG1F Comm. Cable P/N	HG2F/3F/4F Comm. Cable P/N
YOKOGAWA	FA-M3	FA-M3(F3SP05, F3SP20, F3SP21, F3SP25, F3SP30, F3SP35, F3SP38, F3SP53, F3SP58, F3FP36, F3BP20, F3BP30)	RS232	F3LC11-1N		
			RS485	F3LC11-2N		
		FA-M3(F3SP05, F3SP21, F3SP25, F3SP28, F3SP35, F3SP38, F3SP53, F3SP58)	RS232	Buit-in Port		
FUJI	FLEX-PC	NB1, NB2, NB3, NJ-CPU-E4, NJ-CPU-A8, NJ-CPU-B16, NS	RS232	Buit-in Port		
			RS485			
			RS232	NB-RS1-AC/DC		
			RS485			
			RS232	NJ-RS2		
			RS485	NJ-RS4		
			RS232	NS-RS1		
	RS485					
	MICREX-F	F55	RS232	NV1L-RS2		
		F70	RS232	NC1L-RS2		
			RS485	NC1L-RS4		
		F80H, F120H, F120S, F140S, F150S	RS232	FFU120B		
			RS485			
		F30, F50, F50H, F55, F60, F70, F70S, F80H, F81, F120H, F120S, F140S, F150S, F250	RS232	FFK120A-C10		
RS485						
Toshiba	PROSECT Series	T1: T1-16,T1-28,T1-40	RS232	Buit-in Port	Contact IDEC*	Contact IDEC*
			RS485	CU111		
		T1S: T1-40S	RS232	Buit-in Port		
			RS485	CU111		
		T2: PU224	RS485	Buit-in Port		
			RS232	Buit-in Port		
		T2E: PU234E	RS485	CM231E		
			RS232	CM232E		
		T2N: PU215N,PU235N, PU245N	RS232	Buit-in Port		
			RS485	Buit-in Port		
		T3/T3H: PU315, PU325, PU325H, PU326H	RS485	Buit-in Port		
			RS485	Buit-in Port		
	V Series	S2I/ S2E/L1/S2/S3: PU672T, PU662T, PU612E, L1PU11H,L1PU12H, S2PU82, S2PU72, S2PU32, S2PU22, S3PU65, S3PU55, S3PU45, S3PU21	RS485	Buit-in Port		
			RS485	Buit-in Port		
LS Industrial Systems	MASTER-K	K10S1	RS232	Buit-in Port		
		K80S, K120S, K200S	RS232	Buit-in Port		
			RS232	G7L-CUEB		
		K80S	RS232	G7L-CUEC		
			RS232	G6L-CUEB		
		K200S	RS232	G6L-CUEC		
			RS232	G4L-CUEA		

PLCs

Operator Interfaces

Automation Software

Power Supplies

Sensors

Communication & Networking



1. \* Consult IDEC for wiring schematic and cable.  
2. Visit [www.idec.com/oi](http://www.idec.com/oi) for the most up-to-date list of cables.

### Specifications

#### General Specifications

Model	HG1F	HG2F	HG3F	HG4F
<b>Voltage</b>	24V DC			
<b>Voltage Range</b>	20.4 to 28.8V DC		19.2 to 28.8V DC	
<b>Power Consumption</b>	10W maximum		25W maximum	
<b>Inrush Current</b>	20A maximum		15A maximum (cold start)	
<b>Allowable Momentary Power Interruption</b>	10 ms minimum			
<b>Dielectric Strength</b>	1,000V AC, 10 mA, 1 minute between power and FG terminals		1,500V AC, 10 mA, 1 minute between power and FG terminals	
<b>Insulation Resistance</b>	50 MΩ minimum between power and FG terminals (500V DC megger)		10 MΩ minimum between power and FG terminals (500V DC megger)	
<b>Backup Battery</b>	CR2032 lithium battery Life approx. 4 years (25°C)		—	
<b>Operating Temperature</b>	0 to 50°C (no freezing)			0 to 45°C (no freezing)
<b>Operating Humidity</b>	10 to 90% RH (no condensation)	10 to 95% RH (no condensation)	20 to 85% RH (no condensation)	
<b>Storage Temperature</b>	-20 to +60°C (no freezing)			
<b>Storage Humidity</b>	10 to 90% RH (no condensation)	10 to 95% RH (no condensation)	20 to 85% RH (no condensation)	
<b>Pollution Degree</b>	2 (IEC 60664-1)			
<b>Corrosion Immunity</b>	Atmosphere free from corrosive gases			
<b>Vibration Resistance (damage limits)</b>	10 to 20Hz amplitude 0.625 mm, 20 to 55Hz acceleration 9.8 m/s <sup>2</sup> (1G), 2 hours per axis on each of three mutually perpendicular axes			
<b>Shock Resistance (damage limits)</b>	147 m/s <sup>2</sup> (15G), 11 ms, 5 shocks on each of three mutually perpendicular axes			
<b>Noise Immunity</b>	Fast transient/burst test, common mode: Level 3, power terminals: ±2 kV, communication line: ±1 kV (IEC/EN 61000-4-4)			
<b>Electrostatic Discharge</b>	ESD-3 (RH-1), Level 3, (contact ±6 kV, aerial ±8 kV) (IEC/EN 61000-4-2)			
<b>Mounting</b>	Panel mounting			
<b>Degree of Protection</b>	IP65 NEMA TYPE 13		IP66 NEMA TYPE 4, 4X, 13	
<b>Dimensions (mm)</b>	147W x 47H x 39.3D	172W x 136H x 56D	324W x 240H x 56D	348W x 270H x 58D
<b>Weight (approx.)</b>	280g	800g	2800g	3400g

#### Operation Specifications

Model	HG1F	HG2F		HG3F	HG4F
		Standard	CC Switch Option		
<b>Switching Element</b>	Resistive membrane				
<b>Touch Region Resolution</b>	1 x 1	16 x 12	16 x 8	32 x 24	40 x 30
<b>CC Switch Quantity</b>	—	—	4 x 1 row (bottom only)	—	—
<b>Operating Force</b>	0.2 to 0.8N		2.5 to 5.0N	0.2 to 0.8N	0.2 to 0.8N
<b>Mechanical Life</b>	1,000,000 operations				
<b>Acknowledge Sound</b>	Electronic buzzer				
<b>Screen Types</b>	Base screen, popup screen, system screen				
<b>Number of Screens</b>	Base screen: 3000 max., popup screen: 3015 max.		Base screen: 3000 max., popup screen: 3000 max.		
<b>User Memory</b>	1MB (including expansion fonts)	2MB		8MB*	
<b>Parts</b>	Bit Button, Word Button, Goto Screen Button, Print Button, Key Button, Keypad, Selector Switch, Potentiometer, Numerical Input, Character Input, Pilot Lamp, Multi-state Lamp, Picture Display, Message Display, Message Switching Display, Alarm List Display, Alarm Log Display, Numerical Display, Bar Graph, Trend Chart, Pie Chart, Meter, Calendar, Bit Write Command, Word Write Command, Goto Screen Command, Timer, Print Command, Screen Script Command				
<b>Calendar</b>	Year, Month, Day, Hour, Min., Sec., Day of Week				
<b>Print Function (support)</b>	ESC/P, PC-PR: Epson VP-700 SII: DPU414			ESC/P, PC-PR, PCL, EPSON LP2500/VP-700/PX-V600/ Stylus C83, C84, C87, C88, D88, HP Deskjet 3820	
<b>Power Failure Backup</b>	Backup data: Calendar, log data, keep internal relay, keep internal register				
<b>Backup Duration</b>	1 month (at 25°C) after full charging for two days				
<b>Battery Life</b>	4 years (at 25°C)		—		

\*2MB for OS

Display Specifications

Model	HG1F	HG2F		HG3F	HG4F	
		Color	Monochrome	Color	Color	
<b>LCD</b>	Monochrome STN	Color STN	Monochrome STN	Color TFT		
<b>Effective Display Area (mm)</b>	115W x 39W	118.2W x 89.4H		211.2W x 158.4H	246W x 184.5H	
<b>Display Resolution</b>	300W x 100H	320W x 240H pixels		640W x 480H pixels	800W x 600H pixels	
<b>LCD Life</b>	50,000 hours minimum			100,000 hours minimum	60,000 hours minimum	
<b>Contrast Adjustment</b>	Possible in steps using the front touch screen					
<b>Backlight</b>	Cold-cathode tube			Cold-cathode tube (2 tubes)		
<b>Backlight Life</b>	50,000 hours nominal (Note)	40,000 hours nominal (Note)		50,000 hours nominal (Note)		
<b>Backlight Control</b>	Automatic OFF					
<b>Backlight Replacement</b>	Possible					
<b>Display Character Size</b>	<b>1/4 size</b>	8 x 8 pixels (Western European language: ISO 8859-1, Central European language: ANSI 1250, Japanese katakana and symbols: JIS 8-bit code)				
	<b>1/2 size</b>	8 x 16 pixels (Western European language ISO 8859-1, Central European language: ANSI 1250, Japanese katakana and symbols: JIS 8-bit code) 16 x 32 pixels, 24 x 48 pixels, 32 x 64 pixels (Western European language: ISO 8859-1)				
	<b>Full size</b>	16 x 16 pixels (Japanese JIS first and second level characters, simplified Chinese, traditional Chinese, Korean)				
	<b>Double size</b>	32 x 32 pixels (Japanese JIS first level characters, Mincho font)				
<b>Quantity of Characters</b>	<b>1/4 size</b>	37 characters x 12 lines	40 characters x 30 lines (40 x 20, cc click type)	80 characters x 60 lines	100 characters x 75 lines	
	<b>1/2 size</b>	37 characters x 6 lines	40 characters x 15 lines (40 x 10, cc click type)		80 characters x 30 lines	100 characters x 37 lines
	<b>Full size</b>	18 characters x 6 lines	20 characters x 15 lines (20 x 10, cc click type)		40 characters x 30 lines	50 characters x 37 lines
	<b>Double size</b>	9 characters x 3 lines	10 characters x 7 lines (10 x 5, cc click type)		20 characters x 15 lines	25 characters x 18 lines
<b>Character Magnification</b>	0.5, 1, 2, 3, 4, and 8 vertically and horizontally					
<b>Character Attribute</b>	Blink (1 or 0.5 sec period), reverse, bold, shadowed					
<b>Graphics Type</b>	Straight line, polyline, polygon, rectangle, circle, ellipse, arc, pie, equilateral polygons (3, 4, 5, 6, 8), paint, bitmap image					
<b>Window Display</b>	3 popup screens + 1 system screen					



Note: The backlight life refers to the time until the surface brightness reduces to a half after using continuously at room temperatures.

PLCs

Operator Interfaces

Automation Software

Power Supplies

Sensors

Communication & Networking

## Interface Specifications

	CF Card Interface Specifications	Parallel Interface Specifications (HG3F/4F)	Ethernet Specifications (HG3F/4F)
<b>Interface Specifications</b>	Compact Flash Type I standard compliant*	—	IEEE 802.3 standard compliant, 10Base-T
<b>Electrical Characteristics</b>	—	Centronics interface compliant	—
<b>Connector</b>	50-pin compact flash card connector	D-sub 25-pin female connector	—



\*Memory size supports up to 512MB.

## Interface Specifications

RS232C	
<b>Electrical Characteristics</b>	EIA RS232C compliant
<b>Transmission Speed</b>	1200, 2400, 4800, 9600, 19200, 38400, 57600, 115200 bps
<b>Synchronization</b>	Asynchronous
<b>Communication Method</b>	Half or full duplex
<b>Control System</b>	Hardware control or none
<b>Connector</b>	D-sub 25-pin female connector

RS485 (422)	
<b>Electrical Characteristics</b>	EIA RS485 (422) compliant
<b>Transmission Speed</b>	1200, 2400, 4800, 9600, 19200, 38400, 57600, 115200 bps
<b>Synchronization</b>	Asynchronous
<b>Communication Method</b>	Half or full duplex
<b>Control System</b>	Hardware control or none
<b>Connector</b>	D-sub 25-pin female connector

Expansion Unit (Digital I/O Unit)		
<b>Applicable Quantity</b>	1	
<b>Mounting Style</b>	Mounted on the rear of the HG unit	
<b>Input</b>	<b>Input Points</b>	16
	<b>Voltage</b>	12 to 24V DC (allowable range 10 to 28V DC)
	<b>Isolation Method</b>	Photocoupler
<b>Output</b>	<b>Output Points</b>	16
	<b>Load Voltage</b>	12 to 24V DC (allowable range 10 to 28V DC)
	<b>Isolation Method</b>	Photocoupler
	<b>Output Signal</b>	NPN open collector
	<b>Output ON Voltage</b>	1.6V maximum
	<b>Output Current</b>	30 mA max. per point, 200 mA total
<b>Connector</b>	24-pin connector (Fujitsu FCN-365P024-AG) 2 connectors for inputs and outputs	

Maintenance Communication	
<b>Electrical Characteristics</b>	EIA RS232C compliant
<b>Transmission Speed</b>	9600, 19200, 38400, 57600, 115200 bps
<b>Synchronization</b>	Asynchronous
<b>Communication Method</b>	Half duplex, proprietary protocol
<b>Connector</b>	Mini DIN 8-pin connector

OI Link Communication	
<b>Electrical Characteristics</b>	EIA RS485 compliant
<b>Transmission Speed</b>	38400, 57600, 115200 bps
<b>Synchronization</b>	Asynchronous
<b>Communication Method</b>	Half duplex, proprietary protocol
<b>Connector</b>	Special connector

PLCs

Operator Interfaces

Automation Software

Power Supplies

Sensors

Communication & Networking

Dimensions & Panel Cutouts

HG1F Dimensions

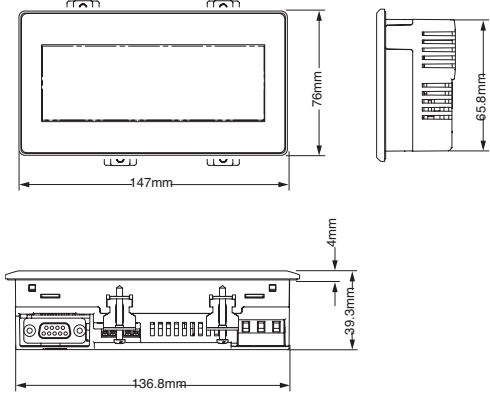

HG1F Installation Panel Layout

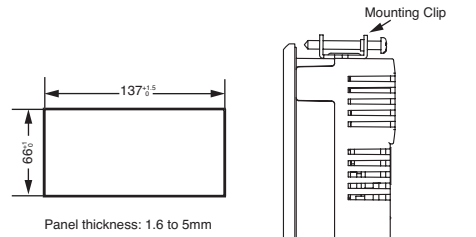

HG2F Dimensions

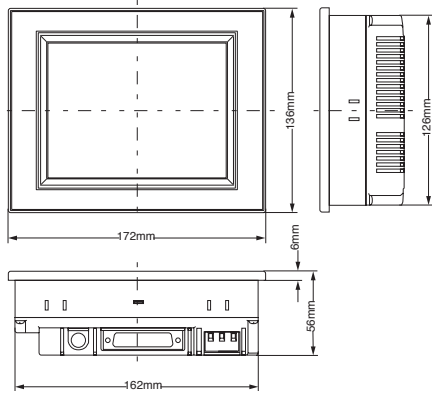

HG2F Installation Panel Layout

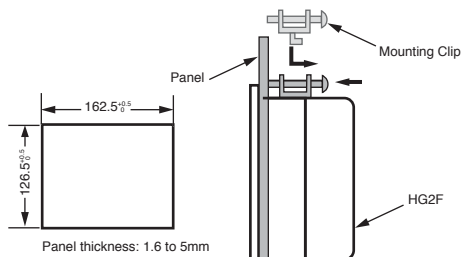

HG3F Dimensions

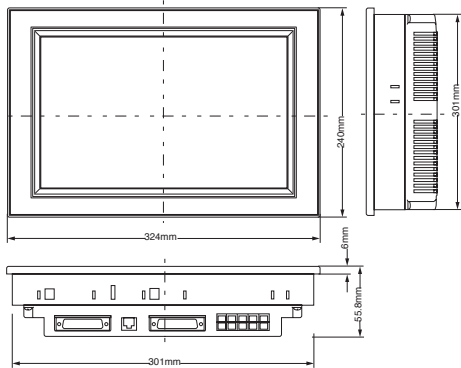

HG3F Installation Panel Layout

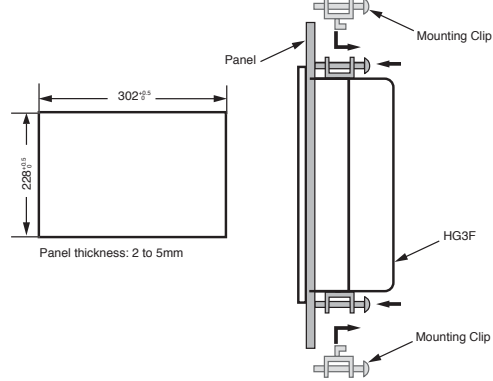

HG4F Dimensions

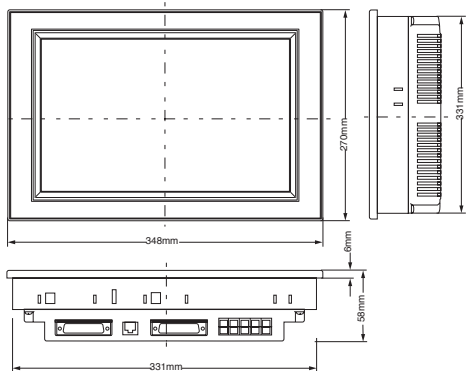

HG4F Installation Panel Layout

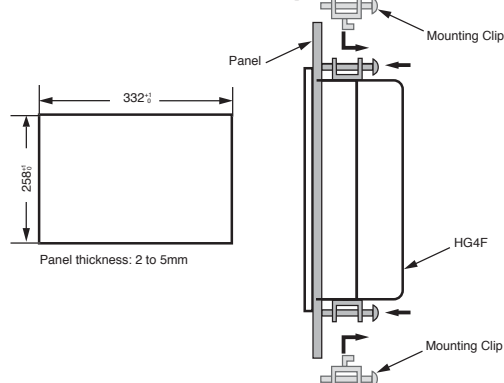

All dimensions in mm.

This document provided by Barr-Thorp Electric Co., Inc. 800-473-9123 www.barr-thorp.com