

Smart Products. Ingenious Solutions.

Wiring Devices, Energy Management
Solutions and Commercial Data
Infrastructure Products

L-200

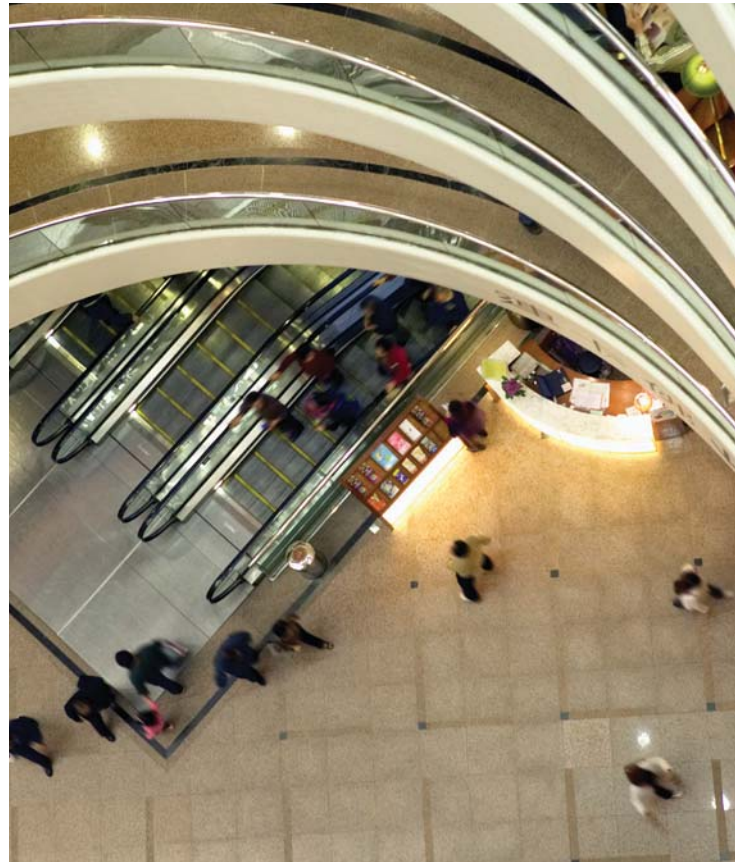

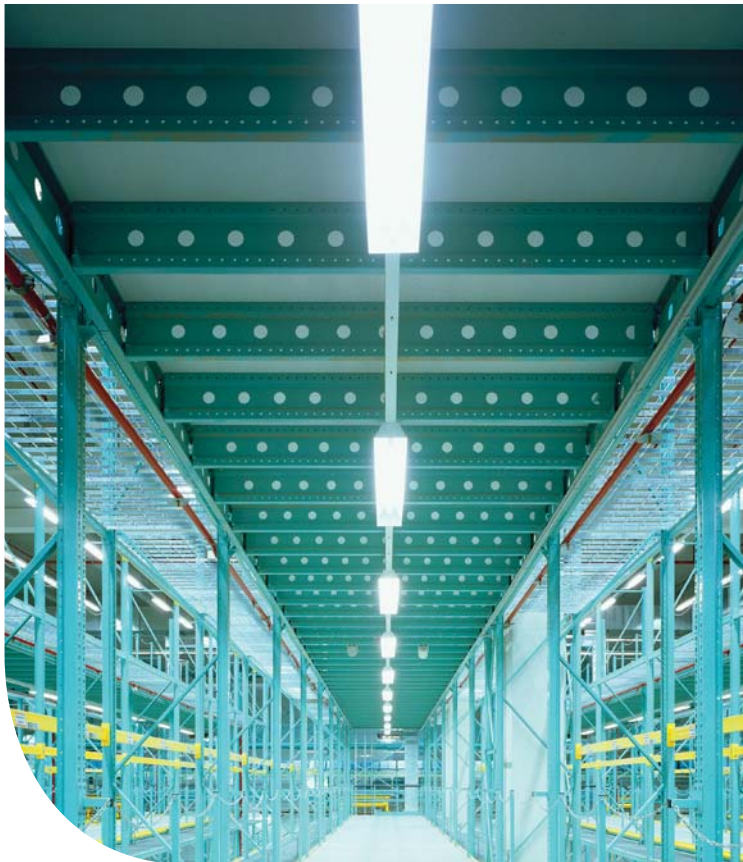
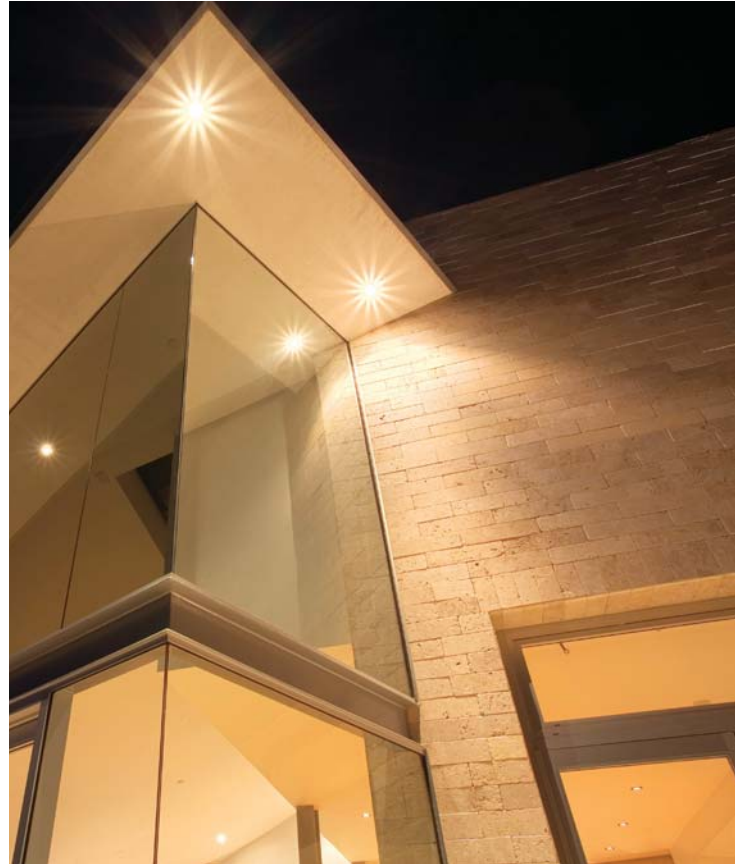

Wallplates and Weather-Resistant Covers

INDEX

Residential and Commercial Grade	
Decora Plus™ Screwless Snap-On	709
Decora®	711
Traditional	715
Combination Wallplates	730
Sectional for Multi-Gang Installations	737
Hot Stamped and Engraved	738
Adapters & Accessories	739
Connectivity Device Plates	742
Industrial and Commercial Grade	
Weather-Resistant Covers	743
Custom Order Form	750

Residential and Commercial Grade

Wallplates and Weather-Resistant Covers

Leviton Decora Plus™ and Decora® Designer Wallplates — available in a wide spectrum of colors and styles — can add subtle elegance to any home. You can go modern with Decora Plus screwless, snap-on wallplates, which install fast and flawlessly. Sleek, versatile and convenient, they now come in a midway size that gives even greater coverage, and can hide unsightly wall surface irregularities. All Leviton Decorative Wallplates can stand up to heavy use while coordinating perfectly with paint or wallcoverings. Think of them as the finishing touch to giving a home its signature look.



DECORA COLORS

Decora devices are offered in a wide range of colors and finishes. To order colors, add suffix to Cat No.



Features and Benefits

All Decora Wallplates

- Accent any wall covering with a wide selection of colors and finishes
- Smooth face and rounded edges resist dust accumulation
- Color-matched metal mounting screws supplied

Thermoset Wallplates

- Designed for high dielectric strength and arc resistance
- Meets or exceeds UL 514 testing requirements
- Resistant to fading, discoloration, grease, oils, organic solvents and moisture scratches
- Limited Two-Year Warranty

Thermoplastic Wallplates

- Molded thermoplastic for maximum resistance to impact, abrasion, fading and discoloration
- Resistant to mechanical stress associated with high abuse applications
- Limited Ten-Year Warranty

Metal Wallplates (Commercial Grade)



- Rounded edges to prevent injury and wall damage
- Deluxe stainless steel is non-magnetic Type 302, .032" thick
- Standard stainless steel Type 430, .032" thick, also available
- Brass is 70/30 alloy 260, .040" thick
- Aluminum is 3004 alloy, .040" thick
- Limited Ten-Year Warranty

Decora Plus™

Specifications and Features

- Sleek, smooth contemporary styling with no mounting screws and no subplate screws for ease of installation and cleaning
- Decora compatible — two-piece kit allows easy use with any Decora installation
- Constructed of durable polycarbonate to with stand abuse
- Screwless subplate offers ease of installation — exclusive “Hook n’ Snap” feature provides an easy, convenient and truly screwless wallplate installation

DECORA PLUS SCREWLESS SNAP-ON (WITH SCREWLESS SUBPLATE)

	Description	Color	Cat. No. Standard Size
	1-Gang	White	80301-SW
		Ivory	80301-SI
		Almond	80301-SA
		Lt. Almond	80301-ST
		Grey	80301-SGY
		Black	80301-SE
		Brown	80301-S
	2-Gang	White	80309-SW
		Ivory	80309-SI
		Almond	80309-SA
		Lt. Almond	80309-ST
		Grey	80309-SGY
		Black	80309-SE
		Brown	80309-S
	3-Gang	White	80311-SW
		Ivory	80311-SI
		Almond	80311-SA
		Lt. Almond	80311-ST
		Black	80311-SE
		Brown	80311-S

Residential and Commercial Grade

	Description	Color	Cat. No. Standard Size
	4-Gang	White Ivory Almond Lt. Almond Black Brown	80312-SW 80312-SI 80312-SA 80312-ST 80312-SE 80312-S
	5-Gang	White Ivory Almond Lt. Almond	80321-SW 80321-SI 80321-SA 80321-ST
	6-Gang	White Ivory Almond Lt. Almond	80326-SW 80326-SI 80326-SA 80326-ST

TESTING AND CODE COMPLIANCE

- UL Listed (File #E-13397)
- Meets NEMA Standards WD-1, WD-6
- CSA Certified (File #LR-16347)
- NOM Certified (#057)

MATERIAL CHARACTERISTICS

Environmental: Flammability UL-94, V2 Rating
Operating Temperature: -40°C to 120°C

DIMENSIONS

Standard Size

80301-S

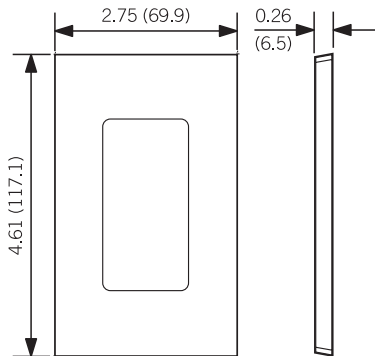





NOTE: Add 1.81" (46.0mm) for each additional gang

Decora® Standard

Specifications and Features

- Accent any wall covering with a wide selection of colors and finishes
- Smooth face and rounded edges resist dust accumulation
- Color-matched mounting screws supplied
- Mounting screws on one-gang Thermoplastic (Nylon) are preinstalled and captive

DECORA STANDARD SIZE

	Description	Color	Thermoset	Thermoplastic (Nylon)	Metal	
	Industry Standard		P26	N26	Industry Standard	
			Cat. No.	Cat. No.		Cat. No.
	1-Gang	White	80401-W	80401-NW	Aluminum	A26 83401
		Ivory	80401-I	80401-NI	Brass	B26 81401
		Almond	80401-A	80401-NA	Polished Brass	81401-PB
		Lt. Almond	80401-T	80401-NT	Non-Magnetic S/S	SN26-N 84401-40
		Grey	80401-GY	80401-NGY		
		Black	80401-E	80401-NE		
		Brown	80401	80401-N		
		Red	—	80401-NR		
		Blue	—	80401-NB		
	Industry Standard		P262	N262		
	2-Gang	White	80409-W	80409-NW	Aluminum	A262 83409
		Ivory	80409-I	80409-NI	Brass	B262 81409
		Almond	80409-A	80409-NA	Polished Brass	81409-PB
		Lt. Almond	80409-T	80409-NT	Non-Magnetic S/S	S262-N 84409-40
		Grey	80409-GY	80409-NGY		
		Black	80409-E	80409-NE		
		Brown	80409	80409-N		
		Red	—	80409-NR		
	Industry Standard		P263	N263		
	3-Gang	White	80411-W	80411-NW	Aluminum	A263 83411
		Ivory	80411-I	80411-NI	Brass	B263 81411
		Almond	80411-A	80411-NA	Polished Brass	81411-PB
		Lt. Almond	80411-T	80411-NT	Non-Magnetic S/S	S263-N 84411-40
		Grey	80411-GY	80411-NGY		
		Black	80411-E	—		
		Brown	80411	80411-N		
	Industry Standard		P264	N264		
	4-Gang	White	80412-W	80412-NW	Brass	B264 81412
		Ivory	80412-I	80412-NI	Non-Magnetic S/S	S264-N 84412-40
		Almond	80412-A	80412-NA		
		Lt. Almond	80412-T	80412-NT		
		Grey	80412-GY	—		
		Black	80412-E	—		
		Brown	80412	80412-N		

Residential and Commercial Grade

DECORA® STANDARD SIZE

Description	Color	Thermoset	Thermoplastic (Nylon)	Metal
Industry Standard		P265		Industry Standard
		Cat. No.	Cat. No.	Cat. No.
5-Gang	White Ivory Almond Lt. Almond Grey Black Brown	80423-W 80423-I 80423-A 80423-T 80423-GY 80423-E 80423		Brass B265 81423 Non-Magnetic S/S S265-N 84423-40
Industry Standard		P262		
6-Gang	White Ivory Almond Lt. Almond Grey Black Brown	80436-W 80436-I 80436-A 80436-T 80436-GY 80436-E 80436		Non-Magnetic S/S S266-N 84436-40
Industry Standard		P267		
7-Gang	White Ivory	80407-W± 80407-I±		
Industry Standard		P264	N264	
8-Gang	White	80408-W±		

± Painted Metal Wallplates

DIMENSIONS

Standard Size Single-Gang

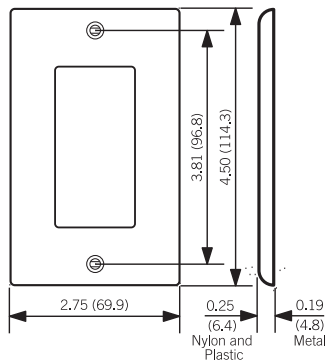





NOTE: Add 1.81" (46.0mm) for each additional gang

Decora® Midway

Specifications and Features

- Midway plates can be used to hide wall surface irregularities
- Full 0.375" taller and wider than standard wallplates
- Available in a wide selection of sizes and colors to complement any wall color or covering
- Smooth face and rounded edges resist dust accumulation
- Color-matched mounting screws supplied

DECORA® MIDWAY SIZE

	Description	Color	Thermoset	Thermoplastic (Nylon)	Metal	
	Industry Standard		P26	N26		Industry Standard
			Cat. No.	Cat. No..		Cat. No.
	1-Gang	White	80601-W	PJ26-W	Non-Magnetic S/S	SSJ26
		Ivory	80601-I	PJ26-I		
		Almond	80601-A	PJ26-A		
		Lt. Almond	80601-T	PJ26-T		
		Grey	—	PJ26-GY		
		Black	—	PJ26-E		
		Brown	80601	PJ26		
		Red	—	PJ26-R		
		Blue	—	PJ26-BU		
	Industry Standard		SPJ262	PJ262		
	2-Gang	White	80609-W	PJ262-W	Non-Magnetic S/S	SJ262
		Ivory	80609-I	PJ262-I		
		Almond	80609-A	PJ262-A		
		Lt. Almond	80609-T	PJ262-T		
		Grey	—	PJ262-GY		
		Black	—	PJ262-E		
		Brown	80609	PJ262		
	Industry Standard		SPJ263	PJ263		
	3-Gang	White	80611-W	PJ263-W	Non-Magnetic S/S	SJ263
		Ivory	80611-I	PJ263-I		
		Almond	80611-A	PJ263-A		
		Lt. Almond	80611-T	PJ263-T		
		Grey	—	PJ263-GY		
		Brown	80611	—		
	Industry Standard		SPJ264	PJ264		
	4-Gang	White	80612-W	PJ264-W		
		Ivory	80612-I	PJ264-I		
		Almond	80612-A	PJ264-A		
		Lt. Almond	80612-T	PJ264-T		
		Grey	—	PJ264-GY		
		Brown	80612	—		

Residential and Commercial Grade

Decora® Oversize

Specifications and Features

- Available in a wide selection of sizes and colors to complement any wall color or covering
- Smooth face and rounded edges resist dust accumulation
- Color-matched mounting screws supplied

DECORA OVERSIZE

Industry Standard	Description	Color	Thermoset	Metal	
			PO26	Industry Standard	
			Cat. No.		Cat. No.
	1-Gang	White	88601-W	Non-Magnetic S/S	S026
		Ivory	86601-I		
		Almond	82601-A		
	2-Gang	White	88602-W	Non-Magnetic S/S	S0262
		Ivory	86602-I		
		Almond	82602-A		
	3-Gang			Non-Magnetic S/S	S0263

DIMENSIONS

Midway Size Single-Gang

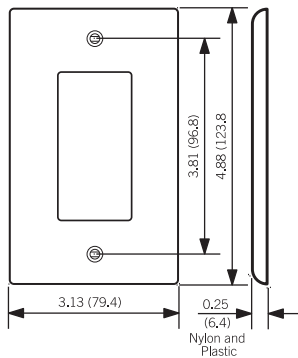

Midway wallplates can be mounted onto larger-volume outlet boxes and/or used to hide wall irregularities. Midway wallplates are a full 0.375" higher and wider than standard size wallplates.

Oversized Single-Gang

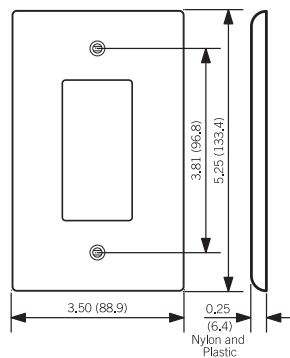

Oversized wallplates are used to conceal greater wall irregularities than those hidden by Midway wallplates. Oversized wallplates are a full 0.75" higher and wider than standard size wallplates. NOTE: Add 1.81" (46.0mm) for each additional gang.

Traditional Wallplates

Familiar and functional, Leviton Traditional Wallplates are designed for use with Traditional Leviton devices. They represent styles and form factors that have stood the test of time. Their clean lines work in virtually any location, whether in new or retrofit construction, and they install quickly and easily. Leviton offers Traditional Wallplates in a vast array of colors and configurations.



Features and Benefits

All Leviton Wallplates

- Easy to clean, smooth finish
- Non-combustible
- Color-matched metal mounting screws supplied
- UL Listed and CSA Certified
- Conforms to NEMA and ANSI Standards

Thermoset (Plastic) Wallplates (Residential Grade)

- Designed for high dielectric strength and arc resistance
- Meets or exceeds UL514 testing requirements
- Resistant to fading, discoloration, grease, oil, organic solvents and moisture scratches
- Limited Two-Year Warranty

Thermoplastic (Nylon) Wallplates (Commercial Grade)

- Molded thermoplastic for maximum resistance to impact, abrasion, fading and discoloration
- Resistant to mechanical stress associated with high abuse applications
- Limited Ten-Year Warranty

Metal Wallplates (Commercial Grade)

- Rounded edges to prevent injury and wall damage
- Deluxe stainless steel is non-magnetic Type 302, .032" thick.
- Standard stainless steel Type 430, .032" thick, also available
- Brass is 70/30 alloy 260, .040" thick
- Limited Ten-Year Warranty

Residential and Commercial Grade

Toggle Standard

Specifications and Features

- Accent any wall covering with a wide selection of colors and finishes
- Color-matched mounting screws supplied
- Mounting screws on one-gang Thermoplastic (Nylon) are preinstalled and captive

TOGGLE STANDARD SIZE

Description	Color	Thermoset	Thermoplastic (Nylon)	Metal		
Industry Standard		P1	N1	Industry Standard		
		Cat. No.	Cat. No.		Cat. No.	
	1-Gang	White	88001	80701-W	Chrome	C1 1901
		Ivory	86001	80701-I	Aluminum	A1 83001
		Almond	82001	80701-A	Brass	B1 81001
		Lt. Almond	78001	80701-T	Polished Brass	81001-PB
		Grey	87001	80701-GY	Stainless Steel	S1 84001
		Black	—	80701-E	Non-Magnetic S/S	S1-N 84001-40
		Brown	85001	80701		
		Red	—	80701-R		
Industry Standard		P2	N2	Industry Standard		
		Cat. No.	Cat. No.		Cat. No.	
	2-Gang	White	88009	80709-W	Chrome	C2 1909
		Ivory	86009	80709-I	Aluminum	A2 83009
		Almond	82009	80709-A	Brass	B2 81009
		Lt. Almond	78009	80709-T	Polished Brass	81009-PB
		Grey	87009	80709-GY	Stainless Steel	S2 84009
		Black	—	80709-E	Non-Magnetic S/S	S2-N 84009-40
		Brown	85009	80709		
		Red	—	80709-R		
Industry Standard		P3	N3	Industry Standard		
		Cat. No.	Cat. No.		Cat. No.	
	3-Gang	White	88011	80711-W	Aluminum	A3 83011
		Ivory	86011	80711-I	Brass	B3 81011
		Almond	82011	80711-A	Polished Brass	81011-PB
		Lt. Almond	78011	80711-T	Stainless Steel	S3 84011
		Grey	87011	80711-GY	Non-Magnetic S/S	S3-N 84011-40
		Black	—	80711-E		
		Brown	85011	80711		
		Red	—	80711-R		
Industry Standard		P4	N4	Industry Standard		
		Cat. No.	Cat. No.		Cat. No.	
	4-Gang	White	88012	80712-W	Aluminum	A4 83012
		Ivory	86012	80712-I	Brass	B4 81012
		Almond	82012	80712-A	Polished Brass	81012-PB
		Lt. Almond	78012-T	80712-T	Stainless Steel	S4 84012
		Grey	87012-GY	—	Non-Magnetic S/S	S4-N 84012-40
		Black	—	80712-E		
		Brown	85012	—		

TOGGLE STANDARD SIZE

Description	Color	Thermoset (Nylon)	Thermoplastic	Metal		
Industry Standard		P5	N5	Industry Standard		
		Cat. No.	Cat. No.			Cat. No.
5-Gang	White	88023-W	80723-W	Brass	B5	81023
	Ivory	86023-I	80723-I	Polished Brass		81023-PB
	Almond	82023-A	—	Non-Magnetic S/S	S5-N	84023-40
	Lt. Almond	78023-T	—			
	Brown	85023	—			
Industry Standard		P6	N6			
6-Gang	White	88036-W	80736-W	Brass	B6	81036
	Ivory	86036-I	80736-I	Non-Magnetic S/S	S6-N	84036-40
	Almond	82036-A	—			
	Lt. Almond	78036-T	—			
	Brown	85036	—			
Industry Standard		S601				
7-Gang	White	S601-W±	—	Non-Magnetic S/S	S601-N	84070-40
	Ivory	S601-I±				
Industry Standard		S602				
8-Gang	White	S602-W±	—	Non-Magnetic S/S	S602-N	84048-40
	Ivory	S602-I±	—			
Industry Standard		S603				
9-Gang	White	S603-W±	—	Non-Magnetic S/S	S603-N	84049-40
	Ivory	S603-I±	—			
Industry Standard		S604				
10-Gang	White	S604-W±	—	Non-Magnetic S/S	S604-N	84050-40
	Ivory	S604-I±	—			

± Painted Metal Wallplates

DIMENSIONS

Standard Size Single-Gang

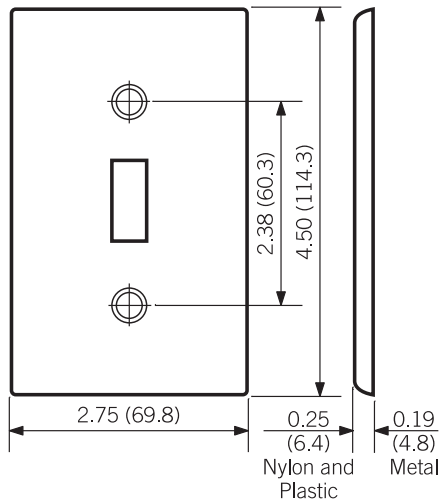

NOTE: Add 1.81" (46.0mm) for each additional gang

Residential and Commercial Grade

LOCKABLE ENCLOSURES AND WALLPLATES

	Description	Mounting	Cat. No.
	Type 1 Steel Enclosure without Switch for 30A Motor Starters	Vertical	N13NC
	Lockout Wallplate (lock sold separately) Non-Magnetic S/S	Vertical	84001-LOK

Toggle Midway

Specifications and Features

- Midway plates can be used to hide wall surface irregularities
- Full 0.375" taller and wider than standard wallplates
- Available in a wide selection of sizes and colors to complement any wall color or covering
- Color-matched mounting screws supplied

TOGGLE MIDWAY SIZE

	Description	Color	Thermoset	Thermoplastic (Nylon)	Metal
	Industry Standard		SPJ1	PJ1	Industry Standard
			Cat. No.	Cat. No.	Cat. No.
	1-Gang	White	80501-W	PJ1-W	Non-Magnetic S/S SSJ1-040
		Ivory	80501-I	PJ1-I	
		Almond	80501-A	PJ1-A	
		Lt. Almond	80501-T	PJ1-T	
		Grey	—	PJ1-GY	
		Black	—	PJ1-E	
		Brown	80501	PJ1	
		Red	—	PJ1-R	
	Industry Standard		SPJ2	PJ2	
	2-Gang	White	80509-W	PJ2-W	Non-Magnetic S/S SSJ2-040
		Ivory	80509-I	PJ2-I	
		Almond	80509-A	PJ2-A	
		Lt. Almond	80509-T	PJ2-T	
		Grey	—	PJ2-GY	
		Black	—	PJ2-E	
		Brown	80509	—	
	Industry Standard		SPJ3	PJ3	
	3-Gang	White	80511-W	PJ3-W	Non-Magnetic S/S SSJ3-040
		Ivory	80511-I	PJ3-I	
		Almond	80511-A	PJ3-A	
		Lt. Almond	80511-T	PJ3-T	
		Black	—	PJ3-E	
		Brown	80511	PJ3	
	Industry Standard		SPJ4	PJ4	
	4-Gang	White	80512-W	PJ4-W	
		Ivory	80512-I	PJ4-I	
		Almond	80512-A	PJ4-A	
		Lt. Almond	80512-T	PJ4-T	
		Brown	80512	—	

Toggle Oversize

Specifications and Features

- Available in a wide selection of sizes and colors to complement any wall color or covering
- Smooth face and rounded edges resist dust accumulation
- Color-matched mounting screws supplied

TOGGLE OVERSIZE

Description		Color	Thermoset	Metal					
Industry Standard			PO1	Industry Standard					
			Cat. No.			Cat. No.			
	1-Gang	White	88101	Stainless Steel	S01	84101			
		Ivory	86101				Non-Magnetic S/S	S01-N	84101-40
		Brown	85101						
Industry Standard			PO2						
	2-Gang	White	88109	Non-Magnetic S/S	S02-N	84109-40			
		Ivory	86109						
		Brown	85109						
Industry Standard			PO3						
	3-Gang	White	88111	Non-Magnetic S/S	S03-N	84111-40			
		Ivory	86111						
	4-Gang			Non-Magnetic S/S	S04-N	84112-40			

DIMENSIONS

Midway Size Single-Gang

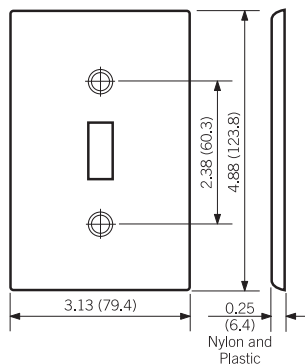

Midway wallplates can be mounted onto larger-volume outlet boxes and/or used to hide wall irregularities. Midway wallplates are a full 0.375" higher and wider than standard size wallplates.

Oversized Single-Gang

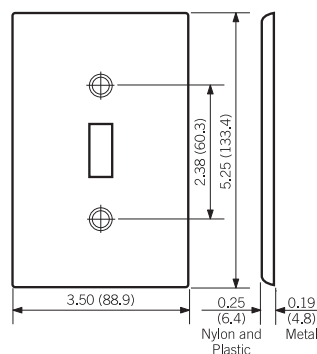



Oversized wallplates are used to conceal greater wall irregularities than those hidden by Midway wallplates. Oversized wallplates are a full 0.75" higher and wider than standard size wallplates. NOTE: Add 1.81" (46.0mm) for each additional gang.

Residential and Commercial Grade



DUPLEX RECEPTACLE STANDARD SIZE

Description	Color	Thermoset	Thermoplastic (Nylon)	Metal			
Industry Standard		P8	NB	Industry Standard			
		Cat. No.	Cat. No.			Cat. No.	
	1-Gang	White	88003	80703-W	Chrome	C8	1903
		Ivory	86003	80703-I	Aluminum	A8	83003
		Almond	82003	80703-A	Brass	B8	81003
		Lt. Almond	78003	80703-T	Polished Brass		81003-PB
		Grey	87003	80703-GY	Stainless Steel	S8	84003
		Black	—	80703-E	Non-Magnetic S/S	S8-N	84003-40
		Brown	85003	80703			
		Red	—	80703-R			
		Blue	—	80703-BU			
		Orange	—	80703-ORG			
		Industry Standard		P82	N82		
	2-Gang	White	88016	80716-W	Aluminum	A82	83016
		Ivory	86016	80716-I	Brass	B82	81016
		Almond	82016	80716-A	Stainless Steel	S82	84016
		Lt. Almond	78016	80716-T	Non-Magnetic S/S	S82-N	84016-40
		Grey	87016	80716-GY			
		Black	—	80716-E			
		Brown	85016	80716			
		Red	—	80716-R			
		Blue	—	80716-BU			
		Orange	—	80716-ORG			
Industry Standard		P83	N83				
	3-Gang	White	88030	80730-W	Non-Magnetic S/S	S83-N	84030-40
		Ivory	86030	80730-I			
		Lt. Almond	78030	—			
		Grey	—	80730-GY			
		Brown	85030	—			
Red	—	80730-R					
Industry Standard		P84					
	4-Gang	White	88041		Stainless Steel	S84	84041
		Ivory	86041				
		Brown	85041				
Industry Standard							
	5-Gang				Non-Magnetic S/S	S85-N	84055-40
Industry Standard							
	6-Gang				Non-Magnetic S/S	S86-N	84056-40

DUPLEX RECEPTACLE MIDWAY

Description	Color	Thermoset	Thermoplastic (Nylon)	Metal		
Industry Standard		SPJ8	PJ8	Industry Standard		
		Cat. No.	Cat. No.	Cat. No.		
	1-Gang	White	80503-W	PJ8-W	Non-Magnetic S/S	SSJ8-40
		Ivory	80503-I	PJ8-I		
		Almond	80503-A	PJ8-A		
		Lt. Almond	80503-T	PJ8-T		
		Grey	—	PJ8-GY		
		Black	—	PJ8-E		
		Brown	80503	PJ8		
		Red	—	PJ8-R		
		Blue	—	PJ8-BU		
Industry Standard		SPJ82	PJ82			
	2-Gang	White	80516-W	PJ82-W	Non-Magnetic S/S	SSJ82-40
		Ivory	80516-I	PJ82-I		
		Almond	80516-A	PJ82-A		
		Lt. Almond	80516-T	PJ82-T		
		Grey	—	PJ82-GY		
		Black	—	PJ82-E		
		Brown	80516	PJ82		
		Red	—	PJ82-R		
Industry Standard						
	3-Gang				Non-Magnetic S/S	SSJ83-40

DUPLEX RECEPTACLE OVERSIZE

Description	Color	Thermoset	Metal			
Industry Standard		P08	Industry Standard			
		Cat. No.	Cat. No.			
	1-Gang	White	88103	Stainless Steel	S08	84103
		Ivory	86103	Non-Magnetic S/S	S08-N	84103-40
		Brown	85103			
Industry Standard		P082				
	2-Gang	White	88116	Stainless Steel	S082	84116
		Ivory	86116	Non-Magnetic S/S	S082-N	84116-40
		Brown	85116			
Industry Standard						
	3-Gang			Non-Magnetic S/S	S083-N	84130-40

Residential and Commercial Grade

STANDARD SIZE SINGLE RECEPTACLE 15A and 20A Straight Blade and 15A Locking (1.406" Diameter Hole)

Description	Color	Thermoset	Thermoplastic (Nylon)	Metal
Industry Standard		P7	N7	Industry Standard
		Cat. No.	Cat. No.	Cat. No.
1-Gang	White	88004	80704-W	Aluminum A7 83004
	Ivory	86004	80704-I	Brass B7 81004
	Almond	82004	80704-A	Non-Magnetic S/S S8-N 84004-40
	Lt. Almond	78004	80704-T	
	Grey	—	80704-GY	
	Black	—	80704-E	
	Brown	85004	80704	
	Red	—	80704-R	
	Orange	—	80704-ORG	
Industry Standard		P72		
2-Gang	White	88052		Non-Magnetic S/S S72-N 84052-40
	Ivory	86052		
	Brown	85052		
3-Gang				Non-Magnetic S/S S73-N S73-N





MIDWAY SIZE SINGLE RECEPTACLE 15A and 20A Straight Blade and 15A Locking (1.406" Diameter Hole)

Description	Color	Thermoset	Thermoplastic (Nylon)	Metal
Industry Standard		SPJ7	PJ7	Industry Standard
		Cat. No.	Cat. No.	Cat. No.
1-Gang	White	80504-W	PJ7-W	Non-Magnetic S/S SSJ7-40
	Ivory	80504-I	PJ7-I	
	Almond	80504-A	PJ7-A	
	Lt. Almond	80504-T	PJ7-T	
	Brown	80504	—	
	Red	—	PJ7-R	



OVERSIZE SINGLE RECEPTACLE 15A and 20A Straight Blade and 15A Locking (1.406" diameter Hole)

Description	Metal
	Industry Standard
	Cat. No.
1-Gang	Non-Magnetic S/S S07-N 84104-40

STANDARD SIZE TELEPHONE OR CABLE OUTLET - BOX MOUNTED

Description				Color	Thermoset	Metal		
Industry Standard						Industry Standard		
						Cat. No.	Cat. No.	
	1-Gang					Aluminum	A738	83013
	Phone/Cable					Brass	B738	81013
	.312" dia.					Polished Brass		81013-PB
	Hole					Stainless Steel	S738	84013
						Non-Magnetic S/S	S7-N	84013-40
Industry Standard						P11		
	1-Gang	White		88013		Non-Magnetic S/S	S11-N	84061-40
	Phone/Cable	Ivory		86013				
	.406" dia.	Almond		82013				
	Hole	Lt. Almond		78013				
		Brown		85013				
Industry Standard						P737		
	1-Gang	White		88017		Brass B73	B737	81017
	Phone/Cable	Ivory		86017		Non-Magnetic S/S	S737-N	84017-40
	.625" dia.							
	Hole							
Industry Standard						P21		
	2-Gang	White		88062-W		Non-Magnetic S/S	S21-N	84062-40
	Phone/Cable	Ivory		86062-I				
	.406" dia.							
	Hole							

MIDWAY SIZE TELEPHONE OR CABLE OUTLET - BOX MOUNTED

Description				Color	Thermoset	Thermoplastic (Nylon)	Metal	
Industry Standard						Industry Standard		
						SPJ738		
						Cat. No.	Cat. No.	
	1-Gang	White		80513-W		Non-Magnetic S/S	SSJ11-40	
	Phone/Cable	Ivory		80513-I				
	.312" dia.	Almond		80513-A				
	Hole	Lt. Almond		80513-T				
Industry Standard						PJ11		
	1-Gang	White				PJ11-W		
	Phone/Cable	Ivory				PJ11-I		
	.406" dia.	Almond				PJ11-A		
	Hole	Lt. Almond				PJ11-T		
		Grey				PJ11-GY		
		Black				PJ11-E		
		Brown				PJ11		



Residential and Commercial Grade

STANDARD SIZE TELEPHONE OR CABLE OUTLET - STRAP MOUNTED

Description	Color	Thermoset	Thermoplastic (Nylon)	Metal
Industry Standard		P12		Industry Standard
		Cat. No.	Cat. No.	Cat. No.
 1-Gang Phone/Cable .406" dia. Hole with knock out to enlarge hole to .625	White Ivory Brown	88018 86018 85018		Non-Magnetic S/S S12-N 84018-40
Industry Standard				N12
 1-Gang Phone/Cable .406" dia. Hole	White Ivory Grey Black Brown			80718-W 80718-I 80718-GY 80718-E 80718
Industry Standard		P730		
 1-Gang Phone/Cable .625" dia. Hole	White	88037		Non-Magnetic S/S S730-N 84037-40
Industry Standard		P22		
 2-Gang Phone/Cable .406" dia. Hole	Ivory	P22-±		

± Painted Metal Wallplates

OVERSIZE TELEPHONE OR CABLE OUTLET - STRAP MOUNTED

Description	Color	Thermoset	Metal
Industry Standard		P012	Industry Standard
		Cat. No.	Cat. No.
 1-Gang Phone/Cable .406" dia. Hole	White Ivory	88113 86113	
 1-Gang Phone/Cable .625" dia. Hole			Non-Magnetic S/S S0730-N 84137-N

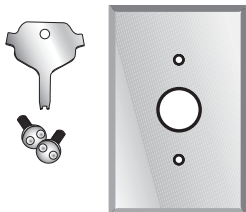

84071-40

WALLPLATE FOR KEYLOCK SWITCHES (1221-2KL SERIES)

Type 302 Stainless Steel Wallplate w/Tamper-Resistant Screws and Spanner Tool

Description	Color	Cat. No.
1-Gang	S/S	84071-40
2-Gang	S/S	84072-40
3-Gang	S/S	84073-40

All devices are UL Listed and CSA Certified.

Blanks

STANDARD SIZE BLANK - BOX MOUNTED

Description	Color	Thermoset	Thermoplastic (Nylon)	Metal	
Industry Standard		P13		Industry Standard	
		Cat. No.	Cat. No.	Cat. No.	
	1-Gang	White	88014	80714-W	Aluminum A13 83014
		Ivory	86014	80714-I	Brass B13 81014
		Almond	82014	80714-A	Stainless Steel S13 84014
		Lt. Almond	78014	80714-T	Non-Magnetic S/S S13-N 84014-40
		Grey	87014	80714-GY	
		Black	—	80714-E	
		Brown	85014	80714	
		Red	—	80714-R	
Industry Standard		P23	P23		
	2-Gang	White	88025	80725-W	Aluminum A23 83025
		Ivory	86025	80725-I	Brass B23 81025
		Almond	82025	80725-A	Polished Brass 81025-PB
		Lt. Almond	78025	80725-T	Stainless Steel S23 84025
		Grey	87025	80725-GY	Non-Magnetic S/S S23-N 84025-40
		Black	—	80725-E	
		Brown	85025	80725	
Industry Standard		P33	N33		
	3-Gang	White	88033	80735-W	Non-Magnetic S/S S33-N 84033-40
		Ivory	86033	80735-I	
		Almond	—	80735-A	
		Grey	—	80735-GY	
		Black	—	80735-E	
		Brown	85033	—	
Industry Standard		P43			
	4-Gang	White	88064		Stainless Steel S43 84064
		Ivory	86064		Non-Magnetic S/S S43-N 84064-40
		Brown	85064		
	5-Gang			Non-Magnetic S/S S53-N 84065-40	
	6-Gang			Non-Magnetic S/S S63-N 84066-40	
	7-Gang			Non-Magnetic S/S S6013-N 84067-40	
	8-Gang			Non-Magnetic S/S S6023-N 84068-40	

Residential and Commercial Grade

MIDWAY SIZE BLANK - BOX MOUNTED

Description	Color	Thermoset	Thermoplastic (Nylon)	Metal
Industry Standard		SPJ13	PJ13	Industry Standard
		Cat. No.	Cat. No.	Cat. No.
1-Gang	White	80514-W	PJ13-W	Non-Magnetic S/S SSJ13-40
	Ivory	80514-I	PJ13-I	
	Almond	80514-A	PJ13-A	
	Lt. Almond	80514-T	PJ13-T	
	Grey	—	PJ13-GY	
	Black	—	PJ13-E	
	Brown	80514	PJ13	
	Red	—	PJ13-R	
Industry Standard		SPJ23	PJ23	
2-Gang	White	80525-W	PJ23-W	
	Ivory	80525-I	PJ23-I	
	Almond	80525-A	PJ23-A	
	Lt. Almond	80525-T	PJ23-T	
	Grey	—	PJ23-GY	
	Black	—	PJ23-E	
	Brown	80525	—	
Industry Standard		SPJ33		
3-Gang	White	80533-W	PJ33-W	
	Ivory	80533-I	PJ33-I	



OVERSIZE BLANK - BOX MOUNTED

Description	Color	Thermoset	Metal
Industry Standard			Industry Standard
		Cat. No.	Cat. No.
1-Gang	White	88114	Stainless Steel S013 84114
	Ivory	86114	Non-Magnetic S/S S013-N 84114-40
	Brown	85114	
2-Gang			Non-Magnetic S/S S023-N 84125-40
3-Gang			Non-Magnetic S/S S033-N 84133-40

STANDARD SIZE BLANK - STRAP MOUNTED

Description	Color	Thermoset	Thermoplastic (Nylon)	Metal			
Industry Standard		P12		Industry Standard			
		Cat. No.	Cat. No.	Cat. No.			
	1-Gang	White Ivory Grey Black Brown Red	88019 86019 — — 85019 —	80719-W 80719-I 80719-GY 80719-E 80719 80719-R	Stainless Steel Non-Magnetic S/S	S14 S14-N	84019 84019-40
Industry Standard		P24					
	2-Gang	White Ivory Black Red	88034 86034 — —	80734-W 80734-I 80734-E 80734-R	Non-Magnetic S/S	S24-N	84034-40
Industry Standard		P34					
	3-Gang	White Ivory	88035 86035		Non-Magnetic S/S	S34-N	84035-40
Industry Standard		P44					
	4-Gang	White Ivory	88057 86057		Non-Magnetic S/S	S44-N	84057-40
	5-Gang				Non-Magnetic S/S	S54-N	S54-N

OVERSIZE SIZE BLANK - STRAP MOUNTED

Description	Metal	
Industry Standard	Industry Standard	
	Cat. No.	
	1-Gang	Non-Magnetic S/S S014-N 84119-40
	2-Gang	Non-Magnetic S/S S024-N 84134-40

Residential and Commercial Grade

Power Outlet Receptacles

STANDARD SIZE POWER OUTLET RECEPTACLE - 1-GANG

Description	Color	Thermoplastic	Metal	
		(Nylon)	Industry Standard	
Industry Standard		N726		
		Cat. No.		Cat. No.
	20A & 30A Locking Receptacle 1.60" dia. Hole	White Ivory Grey Black Brown Red	80720-W 80720-I 80720-GY 80720-E 80720 80720-R	Non-Magnetic S/S S720-N 84020-40
Description			Metal	
Industry Standard			Industry Standard	
				Cat. No.
	30A and 50A Receptacle 2.15" dia. Hole		Aluminum Brass Finish Steel Aluminum Finish Steel Stainless Steel	A724 B724 S724-GY S724 83028 4928 4927 84028

Note: Use with 278, 279, 5206, 5207, 5371, 5372, 5374

MIDWAY SIZE POWER OUTLET RECEPTACLE - 1-GANG

Description	Color	Thermoset	Thermoplastic
			(Nylon)
Industry Standard		P724	N724
		Cat. No.	Cat. No.
	30A and 50A Receptacle 2.15" dia. Hole	White Ivory Grey Black Brown	80528-W 80528-I — 80528-E —
			80728-W 80728-I 80728-GY 80728-E 80728

Note: Use with 278, 279, 5206, 5207, 5371, 5372, 5374

STANDARD SIZE POWER OUTLET RECEPTACLE - 2-GANG

Description	Color	Thermoset	Thermoplastic (Nylon)	Metal		
				Industry Standard	Cat. No.	Cat. No.
Industry Standard		PJ703	N703	Industry Standard		
		Cat. No.	Cat. No.			Cat. No.
30A and 50A Receptacle 2.15" dia. Hole	White Ivory Black Brown	80526-W 80526-I 80526-BLK —	80726-0W 80726-I — 80726	Aluminum Aluminum Finish Steel Stainless Steel	A703 S703-GY S703	83026 4934 84026
30A and 50A Receptacle, 2.465" dia. Hole.	White Ivory Almond Lt. Almond Black	80530-W 80530-I 80530-A 80530-T 80530-BLK		Aluminum Finish Steel Non-Magnetic S/S	S701-GY	S701-GY S701-40
30A and 50A Receptacle 2.15" dia. Hole Offset				Stainless Steel	S705	84022

Note: Use with 278, 279, 5206, 5207, 5371, 5372, 5374

STANDARD SIZE METAL 2-GANG WITH CENTERED OPENING

Description	Metal		
Industry Standard	Industry Standard		
		Cat. No.	
1-Decora	Non-Magnetic S/S	S746-N	S746-N
1-Toggle	Brass Non-Magnetic S/S	S740-N	81040 84040-40
1-Duplex	Non-Magnetic S/S	S748-N	84039-40
1-Outlet 1.406" dia. Hole	Non-Magnetic S/S	S747-N	84092-40

STANDARD SIZE LOUVRE

Description	Color	Painted Steel	Metal		
Industry Standard		P760	Industry Standard		
		Cat. No.			Cat. No.
1-Gang, Center Horizontal - Box Mount	White Ivory	88079 86079	Brass Non-Magnetic S/S	B760 S760-N	81079 84079-40
Industry Standard		P771			
1-Gang Horizontal - Strap Mount	White Ivory Almond	88080 86080 82080	Brass Non-Magnetic S/S	B771 S771-N	81080 84080-40
2-Gang, 2-Louvre, Horizontal- Strap Mount			Non-Magnetic S/S	S772-N	84081-40

Residential and Commercial Grade

Combination Wallplates

Need a wallplate that does more than one job? Turn to the Combination Wallplates line. Leviton Combination Wallplates come in a variety of configurations and gangs, and are available in a broad selection of materials including, aluminum, brass, stainless steel and plastic, and in an assortment of colors. If you have a unique application, Leviton can also customize a wallplate for a specific job.

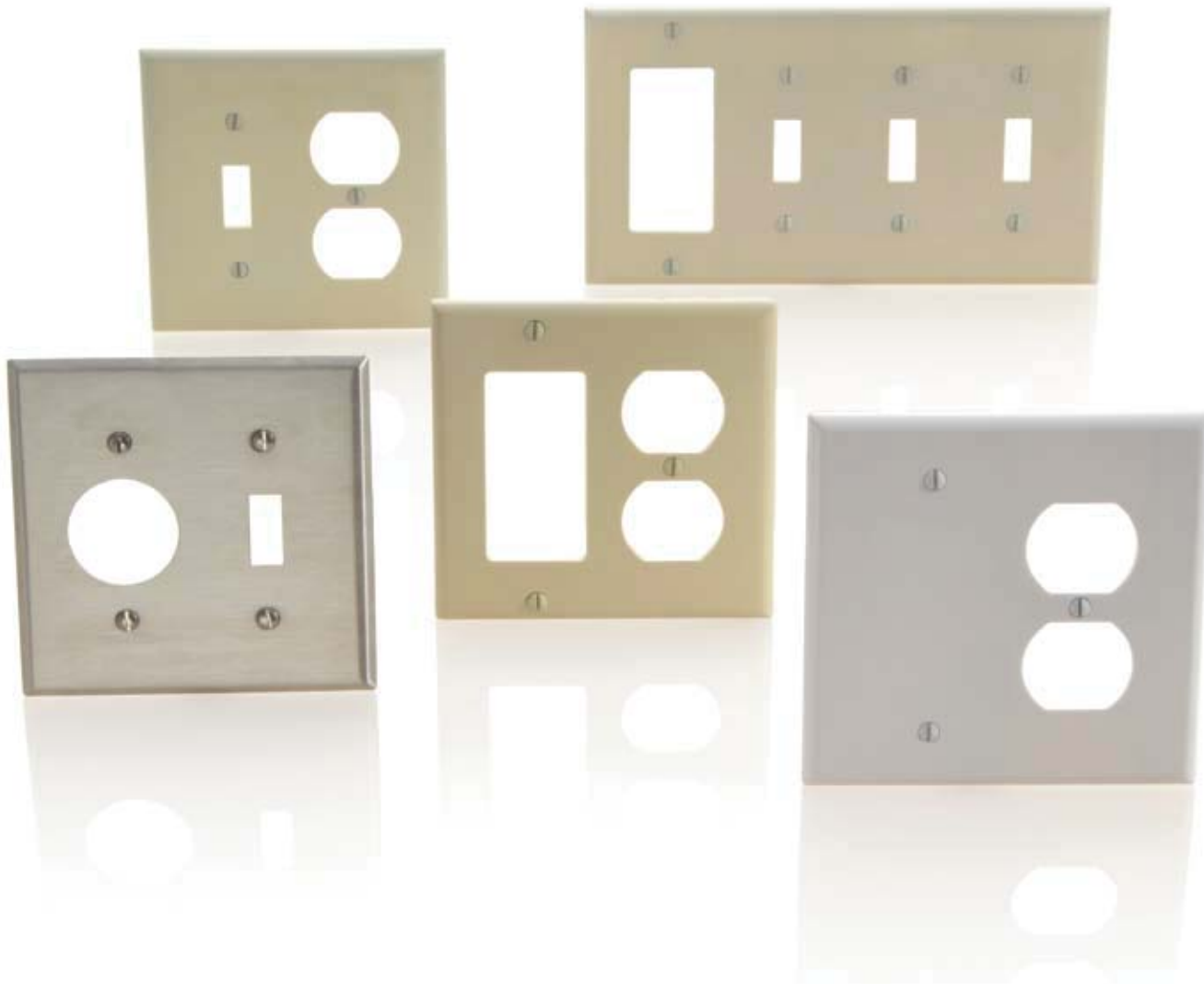

Standard Size Combination

TOGGLE SWITCH AND SINGLE RECEPTACLE

Industry Standard	Description	Color	Thermoset		Metal		
			P1		Industry Standard		
			Cat. No.				Cat. No.
	2-Gang	White	88007		Stainless Steel	S17	84007
	1-Toggle, 1-Single. 1.406" dia Hole	Ivory	86007		Non-Magnetic S/S	S17-N	84007-40
	3-Gang				Non-Magnetic S/S	S27-N	84088-40
	2-Toggle, 1-Single 1.406" dia. Hole						
	4-Gang				Non-Magnetic S/S	S23-N	84042-40
	3-Toggle, 1-Single 1.406" dia. Hole						

TOGGLE SWITCH AND DUPLEX RECEPTACLE

Industry Standard	Description	Color	Thermoset		Metal		
			P18	N18	Industry Standard		
			Cat. No.	Cat. No.			Cat. No.
	2-Gang	White	88005	80705-W	Aluminum	A18	83005
	1-Toggle,	Ivory	86005	80705-I	Brass	B18	81005
	1-Duplex	Almond	82005	80705-A	Stainless Steel	S18	84005
		Lt. Almond	78005	80705-T	Non-Magnetic S/S	S18-N	84005-40
		Grey	87005	80705-GY			
		Black	—	80705-E			
		Brown	85005	80705			
		Red	—	80705-R			
	3-Gang	White	88021	80721-W	Brass	B28	81021
	2-Toggle,	Ivory	86021	80721-I	Non-Magnetic S/S	S28-N	84021-40
	1-Duplex	Almond	82021	—			
		Lt. Almond	78021	—			
		Black	—	80721-E			
	4-Gang	White	P38-W	80743-W	Stainless Steel	S38	84043
	3-Toggle,	Ivory	P38-I	80743-I			
	1-Duplex	Almond	P38-A	—			
		Lt. Almond	P38-T	—			
		Brown	P38	—			
	5-Gang	White	P48-W±		Non-Magnetic S/S	S48-N	S48-N
	4-Toggle,	Ivory	P48-I±				
	1-Duplex						

Residential and Commercial Grade

TOGGLE SWITCH AND DECORA/GFCI

	Description	Color	Thermoset	Thermoplastic (Nylon)	Metal		
	Industry Standard		P126	N126	Industry Standard		
			Cat. No.	Cat. No.			Cat. No.
	2-Gang 1-Toggle, 1-Decora/GFCI	White Ivory Almond Lt. Almond Grey Black Brown Red	80405-W 80405-I 80405-A 80405-T 80405-GY 80405-E 80405 80707-R	80707-W 80707-I 80707-A 80707-T 80707-GY 80707-E 80707 80707-R	Stainless Steel	S126	S126
	Industry Standard		P226	N226			
	3-Gang 2-Toggle, 1-Decora/GFCI	White Ivory Almond Lt. Almond Black Brown	80421-W 80421-I 80421-A 80421-T 80421-E 80421	80745-W 80745-I — — 80745-E —	Non-Magnetic S/S	S226-N	84421-40
	Industry Standard		P1262	N1262			
	3-Gang 2-Decora/GFCI, 1-Toggle	White Ivory Almond Lt. Almond Black Brown	80431-W 80431-I 80431-A 80431-T — 80431	80731-W 80731-I — — 80731-E —			
	Industry Standard		P326	N326			
	4-Gang 3-Toggle, 1-Decora/GFCI	White Ivory Almond Lt. Almond Brown	P326-W P326-I P326-A P326-T P326	80732-W 80732-I — — —			
	Industry Standard		P2262				
	4-Gang 2-Toggle, 2-Decora/GFCI	White Ivory	P2262-W± P2262-I±				
	5-Gang 4-Toggle, 1-Decora/GFCI				Non-Magnetic S/S	S426-N	S426-N

TOGGLE SWITCH AND BLANK

Description	Color	Thermoset	Thermoplastic (Nylon)	Metal
Industry Standard		SPJ28		Industry Standard
		Cat. No.	Cat. No.	Cat. No.
2-Gang 1-Toggle, 1-Blank - Box Mounted	White Ivory Brown	88006 86006 85006		Non-Magnetic S/S S113-N 84006-40
2-Gang 1-Toggle, 1-Blank - Strap Mounted	White Ivory Almond Lt. Almond Grey Red		80706-W 80706-I 80706-A 80706-T 80706-GY 80706-R	Non-Magnetic S/S S114-N 84077-40
3-Gang 2-Toggle 1-Blank - Strap Mounted				Non-Magnetic S/S S214-N S214-N
2-Gang 1-Blank, 1-Decora/GFCI Strap Mount	White Ivory Almond Lt. Almond Grey Black Brown	P1426-W± P1426-I±	80708-W 80708-I 80708-A 80708-T 80708-GY 80708-E 80708	Non-Magnetic S/S S1426-N S1426-N
Industry Standard		P182		
3-Gang 1-Toggle, 2-Duplex	White Ivory Brown	88047 86047 85047	80747-W 80747-I —	Non-Magnetic S/S S182-N 84047-40
4-Gang 2-Toggle, 2-Duplex				Brass B282 81045 Non-Magnetic S/S S282-N 84045-40

± Painted Metal Wallplates

Residential and Commercial Grade

STANDARD COMBINATION OPENINGS

Description	Color	Thermoset	Thermoplastic (Nylon)	Metal
Industry Standard		SPJ18	PJ18	Industry Standard
		Cat. No.	Cat. No.	Cat. No.
 2-Gang 1-Single 1.406" dia. Hole 1-Duplex	White Ivory	88046-W± 86046-I±		Non-Magnetic S/S S78-N 84046-40
Industry Standard		P826		
 2-Gang 1-Duplex 1-Decora/GFCI	White Ivory Almond Lt. Almond Grey Black Brown Red	80455-W 80455-I 80455-A 80455-T — — 80455 —	80746-W 80746-I 80746-A 80746-T 80746-GY 80746-E 80746 80746-R	Non-Magnetic S/S S826-N 84455-40
Industry Standard		P112		
 2-Gang 1-Toggle 1-Phone/Cable .406" dia. Hole - Strap Mount	White Ivory	88077 86077		Non-Magnetic S/S S112-N S112-N
 2-Gang 1-Phone/Cable .406" dia. Hole, 1-Duplex, Strap Mount	White Ivory	88078 86078		Non-Magnetic S/S S128-N 84078-40
Industry Standard		P1226		
 2-Gang 1-Phone/Cable .406" dia. Hole 1-Decora - Strap Mount	White Ivory	80479-W 80479-I		
Industry Standard		P138	N138	
 2-Gang 1-Blank 1-Duplex, Box Mount	White Ivory Brown	88008 86008 85008	— N138-I —	Non-Magnetic S/S S138-N 84008-40
Industry Standard		P148		
 2-Gang 1-Blank 1-Duplex, Strap Mount	White Ivory	88087± 86087±		Non-Magnetic S/S S148-N 84087-40
Industry Standard		P148		
 2-Gang 1-Blank 1-Single 1.406" dia. Hole Strap Mount	White Ivory	88085± 86085±		Non-Magnetic S/S S147-N 84085-40

± Painted Metal Wallplates

Midway Size Combination

TOGGLE SWITCH AND DUPLEX RECEPTACLE

	Description	Color	Thermoset	Thermoplastic (Nylon)
	Industry Standard		SPJ18	PJ18
			Cat. No.	Cat. No.
	2-Gang	White	80505-W	PJ18-W
	1-Toggle,	Ivory	80505-I	PJ18-I
	1-Duplex	Almond	80505-A	PJ18-A
		Lt. Almond	80505-T	PJ18-T
		Black	—	PJ18-E
		Brown	—	PJ18
	Industry Standard		SPJ28	
	3-Gang	White	80521-W	PJ21-W
	2-Toggle,	Ivory	80521-I	PJ21-I
	1-Duplex	Almond	80521-A	—
		Lt. Almond	80521-T	PJ21-T
		Brown	80521	—

± Painted Metal Wallplates

TOGGLE SWITCH AND DECORA/GFCI

	Description	Color	Thermoset	Thermoplastic (Nylon)
	Industry Standard		P126	N126
			Cat. No.	Cat. No.
	2-Gang	White	80605-W	PJ126-W
	1-Toggle,	Ivory	80605-I	PJ126-I
	1-Decora/GFCI	Almond	80605-A	PJ126-A
		Lt. Almond	80605-T	PJ126-T
		Brown	—	PJ126
	Industry Standard			PJ226
	3-Gang	White		PJ226-W
	2-Toggle,	Ivory		PJ226-I
	1-Decora/GFCI	Almond		PJ226-A
		Lt. Almond		PJ226-T
		Brown		PJ226

TOGGLE SWITCH AND BLANK

	Description	Color	Thermoset
	Industry Standard		SPJ113
			Cat. No.
	2-Gang	White	80506-W
	1-Toggle,	Ivory	80506-I
	1-Blank -	Brown	85006
	Box Mounted		

Residential and Commercial Grade

STANDARD COMBINATION OPENINGS

	Description	Color	Thermoset	
Industry Standard			SPJ138	
			Cat. No.	
	2-Gang	White	80508-W	
	1-Blank,	Ivory	80508-I	
	1-Duplex			
	Box Mount			
Industry Standard			SPJ1426	
	2-Gang	White	80608-W	
	1-Blank,	Ivory	80608-I	
	1-Decora/GFCI	Almond	80608-A	
	Strap Mount	Lt. Almond	80608-T	
		Brown	80608	
Industry Standard			PJ826	
	2-Gang	White	PJ826-W	
	1-Duplex,	Ivory	PJ826-I	
	1-Decora/GFCI	Almond	PJ826-A	
		Lt. Almond	PJ826-T	

Oversize Size Combination

TOGGLE SWITCH AND DUPLEX RECEPTACLE



	Description	Color	Thermoset	Metal
Industry Standard			P018	Industry Standard
			Cat. No.	Cat. No.
	2-Gang 1-Toggle,	White	88105	Non-Magnetic S/S S018-N 84105-40
	1-Duplex	Ivory	86105	
	3-Gang 2-Toggle,			Non-Magnetic S/S S028-N 84121-40
	1-Duplex			

TOGGLE SWITCH AND BLANK

	Description	Color	Thermoset	
Industry Standard			P0113	
			Cat. No.	
	2-Gang 1-Toggle,	White	88106	
	1-Blank - Box	Ivory	86106	
	Mounted			

± Painted Metal Wallplates

STANDARD COMBINATION OPENINGS

Description	Color	Thermoset	Metal
Industry Standard		P0138	Industry Standard
		Cat. No.	Cat. No.
 2-Gang 1-Blank, 1-Duplex Box Mount	Ivory	86108	
 2-Gang 1-Single 1.406" dia. Hole, 1-Duplex			Non-Magnetic S/S S078-N 84146-40
 3-Gang 1-Toggle, 2-Duplex			Satin Finish S0782-N 84147-40

Thermoplastic and Metal

THERMOPLASTIC (NYLON) SECTIONALS FOR MULTI-GANG INSTALLATIONS*

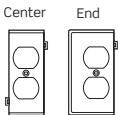
Description	Color	Center Panel	End Panel
		Cat. No.	Cat. No.
 Center End Duplex Receptacle	White	PSC8-W	PSE8-W
	Ivory	PSC8-I	PSE8-I
	Lt. Almond	PSC8-T	PSE8-T
Toggle Switch	White	PSC1-W	PSE1-W
	Ivory	PSC1-I	PSE1-I
	Lt. Almond	PSC7-T	PSE7-T
Single Receptacle, 1.406" dia. Hole	White	PSC7-W	PSE7-W
	Ivory	PSC7-I	PSE7-I
Blank, Strap Mount	White	PSC14-W	PSE14-W
	Ivory	PSC14-I	PSE14-I
	Lt. Almond	PSC14-T	PSE14-T
Decora Panels	White	PSC26-W	PSE26-W
	Ivory	PSC26-I	PSE26-I
	Lt. Almond	PSC26-T	PSE26-T

*Outer dimensions of Wallplates created from two or more sectional panels will be the same as standard multi-gang plates.

HORIZONTAL SPLIT PLATE FOR TERMINATED CABLE

Description	Color	Thermoplastic (Nylon)	Metal
Industry Standard			Industry Standard
		Cat. No.	Cat. No.
 1-Gang .625" dia. hole with Grommet .406" Inner dia.	White Ivory	N751-W N751-I	Satin Finish S751-N Stainless Steel S751-N



Residential and Commercial Grade

Hot Stamped and Engraved



STANDARD SIZE HOT STAMPED AND ENGRAVED

Description	Color	Thermoplastic	Metal
		(Nylon)	
Industry Standard		Cat. No.	Industry Standard
			Cat. No.
1-Gang 1-Duplex Stamped and Engraved "Emergency"	Red	80703-RE	Non-Magnetic S/S 84003-E4
2-Gang 2-Duplex Stamped and Engraved "Emergency"	Red	80716-RE	Non-Magnetic S/S 84016-E4
1-Gang 1-Duplex Stamped and Engraved "Isolated Ground"	Orange	80703-IG	Non-Magnetic S/S 84003-IG
2-Gang 2-Duplex Stamped and Engraved "Isolated Ground"	Orange	80716-IG	
1-Gang 1-Single 1.406" dia. Hole Stamped and Engraved "Isolated Ground"	Orange	80704-IG	
1-Gang 1-Decora Stamped "Isolated Ground"	Orange	80401-IG	
1-Gang 1-Decora Stamped "GFCI"	White Ivory	80401-GFW 80401-GFI	
1-Gang 1-Decora Stamped "Computer Only"	Ivory	80401-COI	
1-Gang 1-Toggle Stamped and Engraved "Emergency"	Red	80701-RE	
1-Gang 1-Duplex Stamped "GFCI Protected"	White Ivory	80703-GFW 80703-GFI	
1-Gang 1-Duplex Stamped "Computer Only"	White Ivory Orange	80703-COW 80703-COI 80703-COO	

MIDWAY SIZE HOT STAMPED AND ENGRAVED







Description	Color	Thermoplastic (Nylon)	Cat. No.
Industry Standard			
 1-Gang 1-Duplex Stamped and Engraved "Emergency"	Red		PJ8-RE
 2-Gang 2-Duplex Stamped and Engraved "Emergency"	Red		PJ82-RE
 1-Gang 1-Duplex Stamped and Engraved "Isolated Ground"	Orange		PJ8-IG

DECORA PLUS STANDARD SIZE PLASTIC ADAPTERS

Description	Color	Cat. No.
	CATV Jack	White 80381-W
		Ivory 80381-I
		Almond 80381-A
		Lt. Almond 80381-T
		Grey 80381-GY
		Black 80381-E
	Blank No Hole	White 80314-W
		Lt. Almond 80314-T
		Grey 80314-GY
		Black 80314-E



Residential and Commercial Grade

PLASTIC ADAPTERS

	Description	Color	Cat. No.
	Dimmer Shaft .406" dia. Hole	White	80400-W
		Ivory	80400-I
		Almond	80400-A
		Lt. Almond	80400-T
		Black	80400-E
		Brown	80400
	Blank Decora No Hole	White	80414-W
		Ivory	80414-I
		Almond	80414-A
		Lt. Almond	80414-T
		Grey	80414-GY
		Black	80414-E
	Blank Toggle No Hole	White	80700-W
		Ivory	80700-I
		Almond	80700-A
		Lt. Almond	80700-T
		Grey	80700-GY
		Brown	80700
	Wallbox Adapter Extends shallow wallbox to fit GFCI/Decora device	White	6197-W
		Ivory	6197-I
		Brown	6197
	Snap-in Grommet reduces 1.406" to 1.00" for use with single receptacle wallplates	Black	403
	Thermoplastic Yoke/Mounting Strap with screws		404

All devices are UL Listed and CSA Certified.

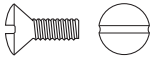

WALLPLATE SCREWS

	Description	Color	Cat. No.
	Oval Head	White	88400-PRT
	Milled Slot	Ivory	86400-PRT
	5/16" long -	Almond	82400-PRT
	6-32 thread,	Lt. Almond	78400-PRT
	100 per box	Grey	87400-PRT
		Stainless Steel	84400-PRT
	Oval Head	White	88000-PRT
	Milled Slot thread,	Ivory	86000-PRT
	1/2" long -	Lt. Almond	78000-PRT
	6-32	Brown	85000-PRT
	100 per box	Stainless Steel	84000-PRT
	Oval Head	White	88500-PRT
	Milled Slot	Ivory	86500-PRT
	6-32 thread,	Lt. Almond	78500-PRT
	7/8" long -		
	50 per box		



MOUNTING SCREWS

	Description	Color	Cat. No.
	Phillips/Standard	Stainless Steel	84400-PRT
	7/8" long -		
	6-32 thread,		
	6-32 thread,		
	100 per box		

TAMPER-RESISTANT SPANNER HEAD WALLPLATE SCREWS

	Description	Color	Cat. No.
	Spanner Head	Stainless Steel	84000-T
	1/2" long -		
	6-32 thread,		
	100 per box		
	Screwdriver for	Black	84000-TSD
	Spanner head or		
	Tamper-Resistant screws		

PILOT LIGHT JEWELS

	Description	Color	Cat. No.
	Round Fits single	Red	405-R
	receptacle hole	Green	405-GR
	1.375-1.406" dia.		
	Rectangular Fits	Red	406-R
	toggle switch hole	Green	406-GR
	.406 x .942"		
	Lampholder Assembly		2152
	for use with jewels or		
	louvre plates - use with		
	standard 2.5" box and		
	4 watt bulb		
	(bulb not included)		

Residential and Commercial Grade

Connectivity Device Plates

Dedicated to 46000 series devices, single-gang Leviton Voice/Data/CATV Wallplates come in standard and Decora styles. They accommodate a Type "F", Db9, Db15 or Bnc/Tnc "D" connectors and are constructed from an impact resistant, engineering grade polymer.



VOICE/DATA/CATV STANDARD SIZE NYLON

	Description	Color	Thermoplastic (Nylon)	Metal
	Industry Standard			Industry Standard
			Cat. No.	Cat. No.
	1-Gang Type "F" Connector	White Ivory Almond Lt. Almond	80781-W 80781-I 80781-A 80781-T	
	1-Gang Duplex Type "F" Connector	Ivory White Almond Lt. Almond	80782-W 80782-I 80782-A 80782-T	
	1-Gang Db9 Data Connector			Non-Magnetic S/S 84441-40
	1-Gang Db15 Data Connector			Non-Magnetic S/S 84442-40
	1-Gang Bnc/Tnc "D" Connector			Non-Magnetic S/S 84444-40

Weather Resistant Covers

Leviton's full line of Raintight and Weather Resistant Covers are ruggedly constructed to seal out moisture, dust, debris and insects, while providing easy access to receptacles. Industrial Grade covers are designed for rugged conditions. Their sturdy, gasketed covers mount vertically or horizontally. Leviton makes two innovative Raintight While-in-Use Covers: telescoping and metal. Designed for decks, patios, porches and similar locations, they're more than a match for the vagaries of weather. The telescoping cover sports a low-profile when in the contracted position, while the metal cover features a self-closing lid made of powder-coated cast zinc. Leviton Weather Resistant Covers let homeowners use power tools, trimmers, sprinkler systems and pumps with confidence and safety. They're also ideal for outdoor security, landscape, accent and holiday lighting.



Specifications and Features

- Glass-filled thermoplastic cover and plate for outstanding impact resistance and durability
- UL 94-VO Flammability Rating
- Superior IP 64 Suitability rating protects against dust particles and splashing water
- NEMA Type 3R enclosure rating ensures protection against rain, sleet and damage from external ice formation
- Dual gaskets, one under plate and one under lid, for weather-resistant fit
- Stainless steel hinge-pin, spring and mounting screws for excellent corrosion resistance
- Triple-combination screws accept Phillips, straight-blade or Robertson-head screwdrivers
- Oversized cover tab for easier opening with gloved hands
- Mounts to panel or FS/FD boxes
- UL Listed and CSA certified for wet locations with cover closed
- Backed by a Limited 10-Year Warranty

Industrial Grade

WEATHER-RESISTANT COVERS



WP2

Description	Color	Cat. No.
For use with 15A locking, 15A and 20A straight-blade flanged inlets and outlets	Grey	WP1
For use with 20A and 30A 3-, 4-, and 5-wire locking flanged inlets and outlets; 30A and 50A 3-wire power receptacles	Grey	WP2
For use with 50A 4-wire power receptacles	Grey	WP3
For use with 50A single locking receptacles and FS/FD Boxes	Grey	7770
	Yellow	7788-CR
For use with 50A single locking receptacles and FS/FD Boxes	Grey	7420-CRG
For use with 20A and 30A FS/FD boxes and single locking receptacles	Yellow	7420-CR

DIE-CAST ZINC WEATHER-RESISTANT COVERS

Description	Mounting	Cat. No.
Single Receptacle 1-Gang	Horizontal	4925-2
Decora/GFCI, 1-Gang	Vertical	4992
Decora/GFCI, 1-Gang	Horizontal	4990
Decora/GFCI, 1-Gang for mounting on FS type box	Vertical	6196-FS
	Horizontal	6196-VFS
Duplex Receptacle, 1-Gang	Vertical	4926
Duplex Receptacle or Combination Device 1-Gang, Two Independent Lids	Horizontal	4970
Weatherproof Wallplate and Switch 15A 120V AC	Horizontal or Vertical	1432
Steel Enclosure without Switch for 30A Motor Starters	Vertical	N13NC
Lockout Wallplate (lock sold separately)	S/S	84001-LOK



Related Products

Leviton offers a complete selection of additional enclosures for motor starters. See page 624 in the Switches Section for more information.

TESTING AND CODE COMPLIANCE

- UL Listed (File # E-13397)
- CSA Certified (File # LR-16347)
- IP 64 Suitability rating (protected against dust and splashing water)
- NEMA Type 3R enclosure rating

MATERIAL CHARACTERISTICS

Environmental: VO Flammability Rating per UL 94
 Operating Temperature: -40°C to 75°C

DIMENSIONS

Water Resistant Cover

WP1 and 7420-CR

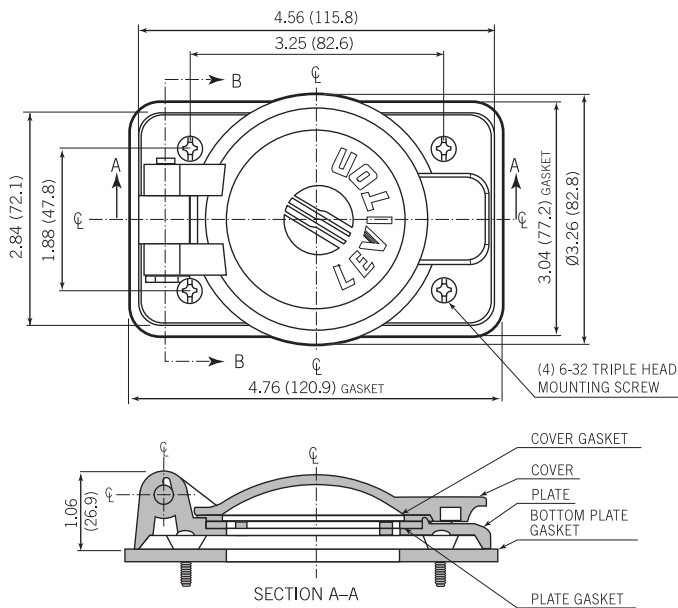

Water Resistant Cover

WP2

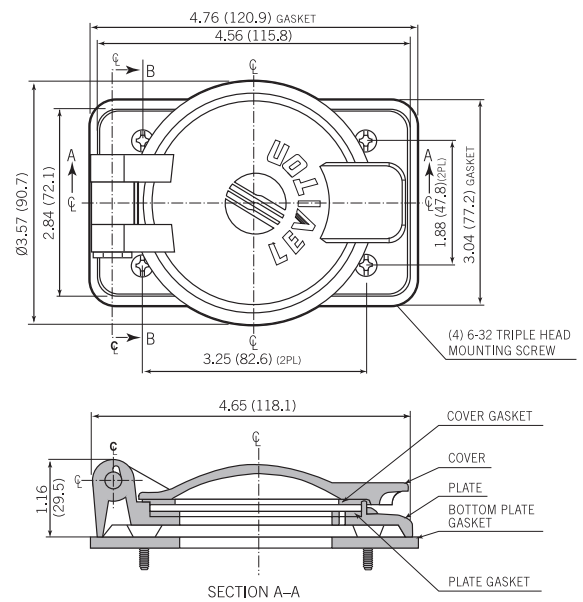

Commercial Grade

Weather Resistant Thermoplastic Covers

Specifications and Features

- Self-closing lid
- Vertical and horizontal mounting
- Impact-resistant thermoplastic covers and bases
- Weather-resistant gaskets
- Stainless steel springs

THERMOPLASTIC WEATHER-RESISTANT COVERS

	Description	Mounting	Color	Cat. No.
	Duplex Receptacle or Combination Device, 1-Gang, Two Independent Lids	Horizontal	White	4976-W
	Duplex Receptacle or Combination Device, 1-Gang, Two Independent Lids	Horizontal	Grey	4976-GY
	Duplex Receptacle or Combination Device, 1-Gang for mounting on FS type box, Two Independent Lids	Horizontal	Grey	4976-FS
	Duplex Receptacle or Combination Device, 1-Gang	Vertical	White	4978-W
	Duplex Receptacle or Combination Device, 1-Gang	Vertical	Grey	4978-GY
	Single Receptacle, 1-Gang	Vertical	Grey	4979-GY
	Single 20A or 30A Locking Receptacle, 1-Gang	Vertical	Grey	4980-GY
	Duplex Receptacle, 1-Gang	Vertical		4926
	Duplex Receptacle or Combination Device 1-Gang, Two Independent Lids	Horizontal		4970
	Decora/GFCI, 1-Gang	Vertical		4992
	Decora/GFCI, 1-Gang	Horizontal		4990

BLANK BOX MOUNTED WALLPLATES WITH GASKET

	Description	Mounting	Cat. No.
	1-Gang Aluminum, Box Mount	N/A	83014-EXT
	2-Gang Aluminum, Box Mount	N/A	83025-EXT

Raintight While-In-Use Covers

Telescoping Raintight While-in-Use Cover

- Tough UV rated thermoplastic construction resists scratching and corrosion
- Extends to While-in-Use position for plugs
- Contracts to shut out insects and debris
- Packaged with duplex and Decora plates, mounting hardware and gaskets

THERMOPLASTIC TELESCOPING RAINLIGHT WHILE-IN-USE COVERS



Description	Mounting	Color	Cat. No.
Duplex, Decora and Single	Vertical	White	T5979-W
Receptacle with Smoke Cover	Vertical	Lt. Almond	T5979-T
	Vertical	Grey	T5979-GY
	Vertical	Brown	T5979

Thermoplastic While-In-Use-Covers

- Self-closing lid
- Impact resistant thermoplastic construction
- Pre-installed gasket for easy, reliable installation
- Offset device opening (horizontal only) for easier cord exit
- Thermoplastic inserts prevent insect and debris accumulation

THERMOPLASTIC RAINLIGHT WHILE-IN-USE COVERS

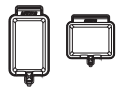

Description	Mounting	Color	Cat. No.
Duplex Receptacle, Standard	Vertical	Grey	5976-GY
	Vertical	Clear	5976-CL
Duplex Receptacle, Extra Deep	Vertical	Grey	5976-DGY
	Vertical	Clear	5976-DCL
Decora/GFCI, Standard	Vertical	Grey	5977-GY
	Vertical	Clear	5977-CL
Decora/GFCI, Extra Deep	Vertical	Grey	5977-DGY
	Vertical	Clear	5977-DCL
Single Receptacle, Standard	Vertical	Grey	5978-GY
	Vertical	Clear	5978-CL
Single Receptacle, Extra Deep	Vertical	Grey	5978-DGY
	Vertical	Clear	5978-DCL
Duplex Receptacle, Standard	Horizontal	Grey	5996-GY
	Horizontal	Clear	5996-CL
Duplex Receptacle, Extra Deep	Horizontal	Grey	5996-DGY
	Horizontal	Clear	5996-DCL
Decora/GFCI, Standard	Horizontal	Grey	5997-GY
	Horizontal	Clear	5997-CL
Decora/GFCI, Extra Deep	Horizontal	Grey	5997-DGY
	Horizontal	Clear	5997-DCL

Commercial Grade

Die-Cast Zinc Raintight While-In-Use Covers

- Powder-coated cast zinc construction resists scratching and corrosion
- Self-closing lid with stainless steel hinge
- Choice of vertical and horizontal mounting
- Includes duplex and Decora plates, mounting hardware and gaskets
- Accepts standard padlock for increased security

DIE-CAST ZINC METAL RAIN-TIGHT WHILE-IN-USE COVERS

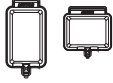

Description	Mounting	Color	Cat. No.
Duplex and Decora Plate Configurations	Vertical	White	M5979-W
Duplex and Decora Plate Configurations	Vertical	Grey	M5979-GY
Duplex and Decora Configurations	Horizontal	White	M5999-W
Duplex and Decora Configurations	Horizontal	Grey	M5999-GY

TESTING AND CODE COMPLIANCE

- Full compliance with UL, CSA and NEC Section 410-57B requirements for damp and wet locations with cover closed
- Raintight While-In-Use covers are NEMA 3R rated for use in wet or damp locations with cover closed and meets NEC® Section 406.8(B)(1) requirements

DIMENSIONS

Vertical Mount Extra Deep

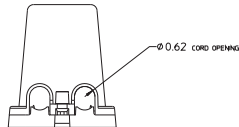
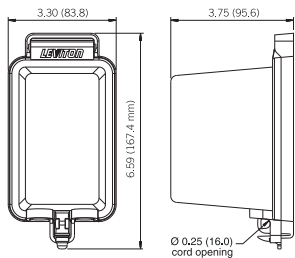

Horizontal Mount, Standard

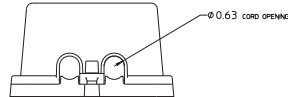
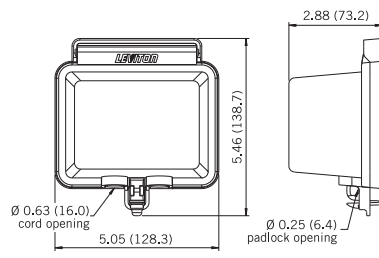

Thermoplastic Telescoping

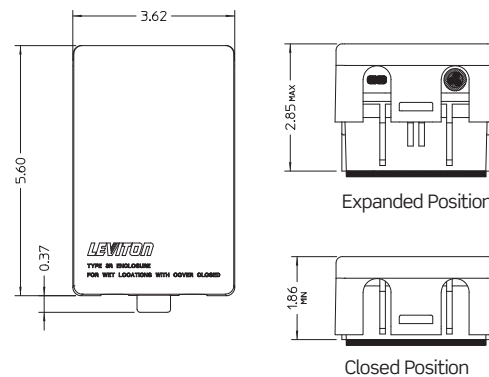

How to Order Custom Wallplates



GENERAL INFORMATION

Custom wallplates, up to twelve gangs in size, made of brass, stainless steel, painted steel, aluminum or chrome, can be special ordered from Leviton. Any combination of the configurations shown can be specified to meet your needs. In addition, standard and custom metal wallplates can be engraved, and standard nylon wallplates can be hot stamped, with the message of your choice. Follow the steps below to fill out the Custom Wallplate Order Form completely and accurately. The finished order form must include:

1. The wallplate catalog number
2. The type of wallplate material desired (from the Material Code Chart)
3. The quantity of wallplates desired
4. The wallplate configurations in proper order (from the Configuration Code Chart)
5. The wallplate color, selected from the Wallplate Color Code Chart
6. Engraved or hot stamped message, if desired, with message location and letter size
7. Engraved or hot stamped message filler color, selected from the Fill-In Color Chart

Photocopy the blank Custom Wallplate Order Form at the back of this section and refer to the completed sample Custom Wallplate Order Form shown when filling out your order. Your Leviton representative can provide you with additional forms if needed. The sample order grid below shows the custom wallplate (example only), pictured at right:

NOTE: Messaging can be written horizontally or vertically. Please contact Leviton for examples of spacing and sizing.

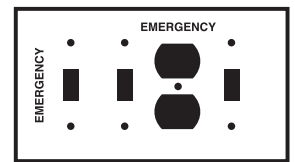

Sample Grid

CAT. NO. 90004 MATERIAL CODE S3 QTY. 1
 (1) (2) (3) (4) (5) (6) (7) (8) (9) (10) (11) (12)

EMERGENCY	01	01	EMERGENCY 03	01								
-----------	----	----	-----------------	----	--	--	--	--	--	--	--	--

COLOR CODE _____ ENGRAVED HOT STAMPED _____ LETTER SIZE 3/8"

FILLER CODE _____ PRICE _____

P.O. # XR

How to Fill Out the Custom Wallplate Order Form

STEP 1: DETERMINE THE WALLPLATE CATALOG NUMBER

The catalog number for a custom wallplate is determined as follows: a single-gang custom wallplate is Cat. No. 90001, a double-gang custom wallplate is Cat.No. 90002, a three-gang custom wallplate is Cat. No. 90003, and so on through the sequence to Cat. No. 90010 for the ten-gang custom wallplate. Enter the number in the space on the Order Form marked "CAT. NO." If you are ordering a standard metal wallplate for custom engraving, use the 90000 series number. If you are ordering a standard nylon wallplate for custom hot stamping, enter that wallplate's catalog number in the space on the Order Form marked "CAT. NO."

STEP 2: SELECT THE WALLPLATE MATERIAL

Choose the custom wallplate material desired from the Wallplate Material Chart below. Enter the Material Code for the material selected in the space marked "MATERIAL CODE" on the Order Form. When ordering Custom Hot Stamped wallplates, enter NYLON.

MATERIAL	MATERIAL CODE
Aluminum*	AL — No Engraving or Hot Stamping
Brass (Satin) Polished Brass	BR PB
Non-Magnetic Stainless Steel-Type 302/304	S3
Oversize Non-Magnetic Stainless Steel-Type 302/304*	S30
Painted Steel	S5
Oversize Painted Steel*	S50
Chrome	CRM
Raw Steel	RAW

*6-Gang maximum size, standard size only

*4-Gang maximum size

STEP 3: DETERMINE THE QUANTITY OF THE WALLPLATE ORDER

Enter the quantity of wallplates needed in the space marked "QUANTITY" on the Order Form.

STEP 4: DETERMINE THE CUSTOM WALLPLATE CONFIGURATION

The Wallplate Configuration Chart below shows all the configurations that can be specified for Leviton custom metal wallplates. Each configuration has a specific Configuration Code number in the lower right-hand corner of its corresponding space on the chart. Enter this configuration code in the center of the corresponding square on the Order Form Grid to match its desired position on the finished custom wallplate. Refer to the Sample Order Form Grid for clarification on configurations and their placement, if necessary (page G43).

Toggle Switch 01	Duplex Receptacle 03	Louvre Horizontal Mount 05	Louvre Vertical Mount* 07	Blank Box Mount 09	Blank Strap Mount 11
Decora/ GFCI 13	Single 1.406" dia. Receptacle 15	1.60" dia. Hole 17	2.15" dia. Hole** 19	2.647" dia. Hole** 21	.312" dia. Hole Strap Mount 23
.312" dia. Hole Box Mount 25	.406" dia. Hole Strap Mount 27	.406" dia. Hole Box Mount 29	.625" dia. Hole Strap Mount 31	.625" dia. Hole Box Mount 33	Interchangeable 1-Device Vertical 35
Interchangeable 1-Device Horizontal 37	Interchangeable 2-Device 39	Interchangeable 3-Device 41	2.460" dia. Hole 2-Gang Only** 47	0.880" dia. Hole for Key Lock Power Switch**. Tamper-resistant screws and screwdriver included w/Key Lock configurations. Device mount unless specified otherwise. For 1-gang, order 84071-40.	
				0.880" dia. Hole for Key Lock Power Switch** 49	

Enter the code number for the configurations you select in the center box on each desired wallplate position on the Custom Wallplate Order Form.

*3-Gang minimum

**2-Gang minimum

How to Fill Out the Custom Wallplate Order Form (continued)

STEP 5: SELECT THE WALLPLATE COLOR

For painted metal, select one of the following colors and enter its color code in the space marked "COLOR CODE" on the order form:

COLOR	WALLPLATE COLOR CODE
Almond	PA
Black	PE
Brown	PB
Gray	PG
Ivory	PI
Orange	PO
Red	PR
White	PW
Lt. Almond	PT

STEP 6: ENTER ENGRAVING INFORMATION

NOTE: WE CAN ENGRAVE NYLON AND PAINTED AND UNPAINTED METAL WALLPLATES. After completing steps 1-5:

6A) Type or clearly print the message(s) (i.e., TURN OFF) as you wish it to appear on the lines provided in the appropriate Grid box(es). 6B) Select the size of the letters you desire for the wallplate message from the dimensions shown below and enter that size in the space marked "LETTER SIZE" on the Order Form. 6C) Select the fill-in color for the message letter from the chart below and enter the code for the color chosen in the space marked "FILLER CODE."

NOTE: Nylon Plates — Engraving or Hot Stamping only on Stock Cat. Numbers.

FILLER COLOR CODES for Engraved Wallplates		LETTER SIZE GAUGE for Engraved Wallplates				
COLOR	CODE	1/8"	3/16"	1/4"	5/16"	3/8"
Black	XE					
White	XW					
Red	XR					
No Filler	XX					

STEP 7: ENTER HOT STAMPING INFORMATION

7A) Select the message(s) desired from the Message Library below. Enter the message on the lines provided in the appropriate Grid box(es) where they should appear. The message will be stamped in 3/16"-high text.

HOT STAMPING MESSAGE LIBRARY FOR CUSTOM NYLON WALLPLATES

1. SHOWER	7. HEAT	13. ON	19. ISOLATED	25. EQUIP
2. VANITY	8. DATA	14. PROTECTED	20. GROUND	26. FLUORESCENT
3. VOICE	9. COMPUTER	15. OFF	21. CONDITIONED	27. OIL
4. ONLY	10. GFCI	16. OIL BURNER	22. CONDITIONED POWER	28. POWER
5. ISOLATED GROUND	11. SURGE	17. PC	23. CRITICAL	29. UPS
6. EMERGENCY	12. FAN	18. DEDICATED	24. ELEC.	

7B) Select the fill-in color for the message letter from the chart below and enter the code for the color chosen in the space marked "FILLER CODE."

COLOR	CODE
Black	XE
White	XW
Red	XR
No Filler	XX

To order nylon wallplates with custom hot stamped message, contact your Leviton salesman or customer service representative.

8) NOTE: Sequential engraving is available. Consult factory for ordering instructions.

CUSTOM WALLPLATE ORDER FORM

BILL TO: _____ _____ _____ _____	SHIP TO: _____ _____ _____ _____
--	--

CAT. NO. _____ MATERIAL CODE _____ QTY. _____

(1)	(2)	(3)	(4)	(5)	(6)	(7)	(8)	(9)	(10)	(11)	(12)
<input type="checkbox"/>	<input type="checkbox"/>	<input type="checkbox"/>	<input type="checkbox"/>	<input type="checkbox"/>	<input type="checkbox"/>	<input type="checkbox"/>	<input type="checkbox"/>	<input type="checkbox"/>	<input type="checkbox"/>	<input type="checkbox"/>	<input type="checkbox"/>

COLOR CODE _____ ENGRAVED _____ HOT STAMPED _____ LETTER SIZE _____
 FILLER CODE _____ PRICE _____ P.O. # _____

Engraving Information (Please print per corresponding gang number.)

(1) <input type="checkbox"/>	<input type="checkbox"/>	<input type="checkbox"/>	<input type="checkbox"/>	<input type="checkbox"/>	<input type="checkbox"/>	<input type="checkbox"/>	<input type="checkbox"/>	<input type="checkbox"/>	<input type="checkbox"/>	<input type="checkbox"/>	<input type="checkbox"/>	(7) <input type="checkbox"/>	<input type="checkbox"/>	<input type="checkbox"/>	<input type="checkbox"/>	<input type="checkbox"/>	<input type="checkbox"/>	<input type="checkbox"/>	<input type="checkbox"/>	<input type="checkbox"/>	<input type="checkbox"/>	<input type="checkbox"/>
(2) <input type="checkbox"/>	<input type="checkbox"/>	<input type="checkbox"/>	<input type="checkbox"/>	<input type="checkbox"/>	<input type="checkbox"/>	<input type="checkbox"/>	<input type="checkbox"/>	<input type="checkbox"/>	<input type="checkbox"/>	<input type="checkbox"/>	<input type="checkbox"/>	(8) <input type="checkbox"/>	<input type="checkbox"/>	<input type="checkbox"/>	<input type="checkbox"/>	<input type="checkbox"/>	<input type="checkbox"/>	<input type="checkbox"/>	<input type="checkbox"/>	<input type="checkbox"/>	<input type="checkbox"/>	<input type="checkbox"/>
(3) <input type="checkbox"/>	<input type="checkbox"/>	<input type="checkbox"/>	<input type="checkbox"/>	<input type="checkbox"/>	<input type="checkbox"/>	<input type="checkbox"/>	<input type="checkbox"/>	<input type="checkbox"/>	<input type="checkbox"/>	<input type="checkbox"/>	<input type="checkbox"/>	(9) <input type="checkbox"/>	<input type="checkbox"/>	<input type="checkbox"/>	<input type="checkbox"/>	<input type="checkbox"/>	<input type="checkbox"/>	<input type="checkbox"/>	<input type="checkbox"/>	<input type="checkbox"/>	<input type="checkbox"/>	<input type="checkbox"/>
(4) <input type="checkbox"/>	<input type="checkbox"/>	<input type="checkbox"/>	<input type="checkbox"/>	<input type="checkbox"/>	<input type="checkbox"/>	<input type="checkbox"/>	<input type="checkbox"/>	<input type="checkbox"/>	<input type="checkbox"/>	<input type="checkbox"/>	<input type="checkbox"/>	(10) <input type="checkbox"/>	<input type="checkbox"/>	<input type="checkbox"/>	<input type="checkbox"/>	<input type="checkbox"/>	<input type="checkbox"/>	<input type="checkbox"/>	<input type="checkbox"/>	<input type="checkbox"/>	<input type="checkbox"/>	<input type="checkbox"/>
(5) <input type="checkbox"/>	<input type="checkbox"/>	<input type="checkbox"/>	<input type="checkbox"/>	<input type="checkbox"/>	<input type="checkbox"/>	<input type="checkbox"/>	<input type="checkbox"/>	<input type="checkbox"/>	<input type="checkbox"/>	<input type="checkbox"/>	<input type="checkbox"/>	(11) <input type="checkbox"/>	<input type="checkbox"/>	<input type="checkbox"/>	<input type="checkbox"/>	<input type="checkbox"/>	<input type="checkbox"/>	<input type="checkbox"/>	<input type="checkbox"/>	<input type="checkbox"/>	<input type="checkbox"/>	<input type="checkbox"/>
(6) <input type="checkbox"/>	<input type="checkbox"/>	<input type="checkbox"/>	<input type="checkbox"/>	<input type="checkbox"/>	<input type="checkbox"/>	<input type="checkbox"/>	<input type="checkbox"/>	<input type="checkbox"/>	<input type="checkbox"/>	<input type="checkbox"/>	<input type="checkbox"/>	(12) <input type="checkbox"/>	<input type="checkbox"/>	<input type="checkbox"/>	<input type="checkbox"/>	<input type="checkbox"/>	<input type="checkbox"/>	<input type="checkbox"/>	<input type="checkbox"/>	<input type="checkbox"/>	<input type="checkbox"/>	<input type="checkbox"/>

DESCRIPTION
 (Use this space to add additional information that may be helpful.)

TERMS

- Please take care to complete your order carefully. Custom wallplates cannot be returned
- Custom orders are shipped in three to four weeks
- All engraving shall be centered within its corresponding gang unless specifically instructed to span across multiple gangs
- All engravings on toggle configurations shall appear above the mounting screw holes unless specifically instructed otherwise
- All engravings on GFCI/Decora configurations shall appear below the mounting screw hole unless specifically instructed otherwise