

Smart Products. Ingenious Solutions.

Wiring Devices, Energy Management
Solutions and Commercial Data
Infrastructure Products

L-200

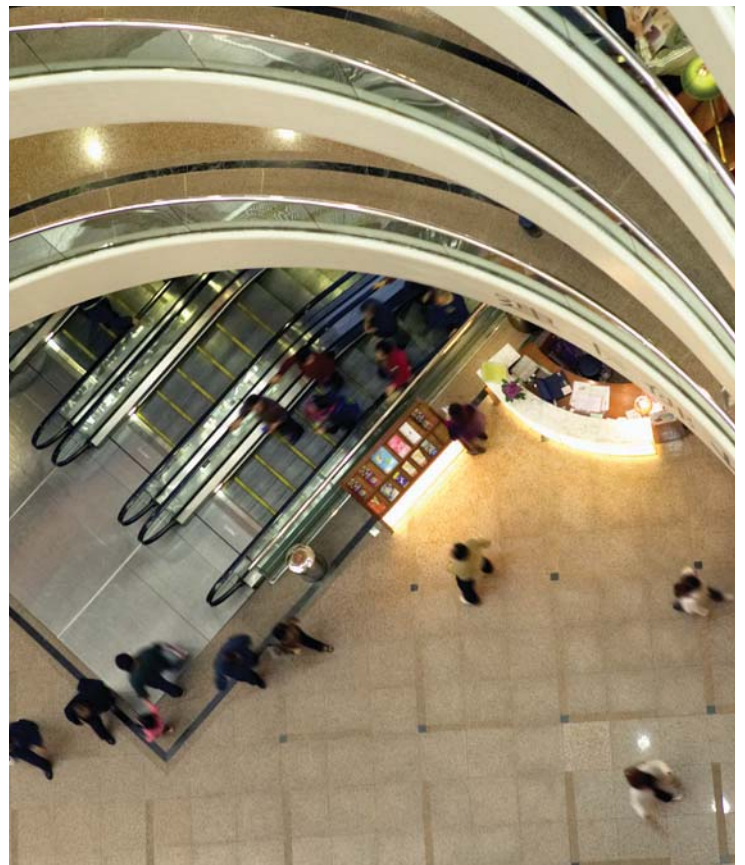

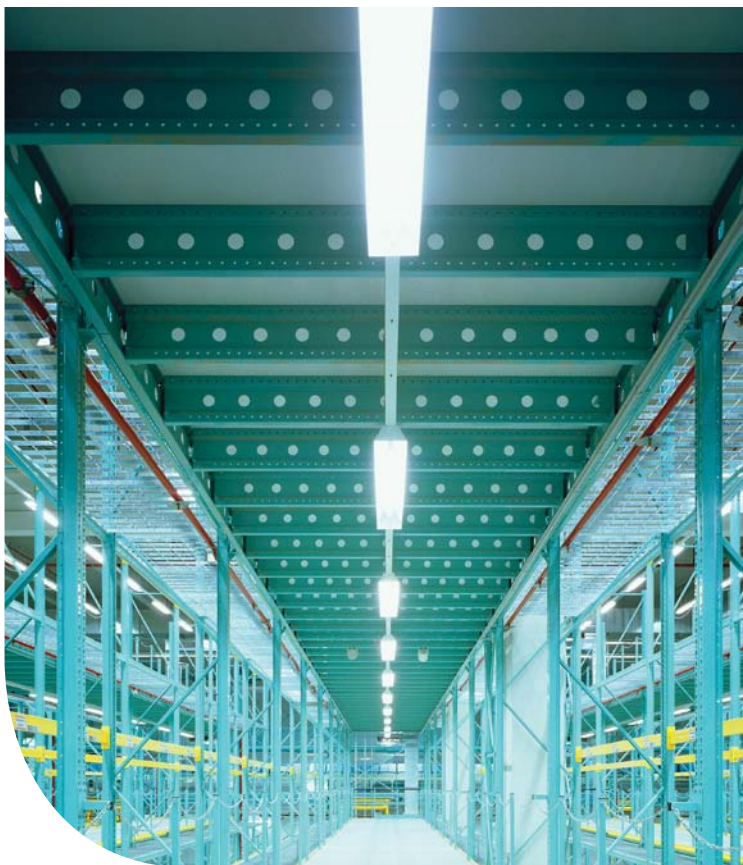
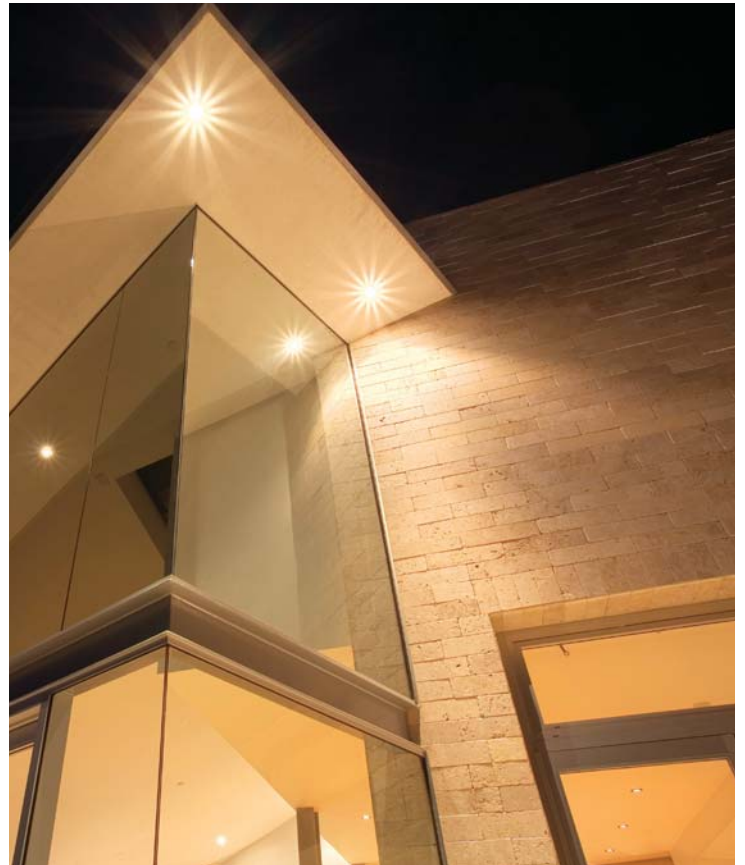

Combination Devices

INDEX

Commercial Grade

Decora®	30
Traditional	34

Residential Grade

Decora® LED Sensor Guide Lights	37
---------------------------------------	----

Combination Devices

With Leviton's extensive assortment of combination devices, you can fill a one-gang space with two switches, a switch and receptacle, a switch and pilot light, three rocker switches — even a single pole switch and a SmartlockPro® GFCI outlet.



Decora®

Part of Leviton's celebrated designer collection, Decora Combination Devices offer switch/switch, switch/receptacle and switch/pilot light pairings in sleek packages suitable for the finest interiors. For the ultimate in convenience and safety, the Decora Combination Switch/SmartlockPro GFCI Receptacles pair a single pole switch with a GFCI receptacle equipped with Leviton's pioneering true dead-face design.

COLORS

Decora devices are offered in a wide range of colors and finishes. To order colors, add suffix to Cat No.



Specifications and Features

- Elegant Decora® styling provides multiple control in a single-gang wallbox
- Impact-resistant thermoplastic and double-wipe contacts
- Common shunted internally to all switches
- Limited Two-Year Warranty

Tamper Resistant Receptacles

- Shutter mechanism inside the receptacle blocks access to the contacts unless a two-prong plug is inserted, helping ensure hairpins, keys, etc., will be locked out
- TR symbol on residential receptacles assures they meet the 2008 NEC requirement
- Heavy-duty construction offers long, trouble-free service life

All SmartlockPro® Combination Devices

- TEST/RESET buttons match device color
- Dual function LED indicator light – provides indication of wiring error and power availability



SmartlockPro GFCI/Sensor Guide Light

- Manual control of sensor light using the TEST/RESET buttons
- Long-lasting, energy efficient LEDs with 20-year life expectancy — no bulbs to replace
- Light sensor provides automatic ON/OFF features

SmartlockPro GFCI/Switch

- Replaces standard switch/outlet combination devices in residential or light commercial installations
- Permits multiple wiring options that allow for GFCI protection of switched load and downstream receptacles

DECORA COMBINATION DEVICES*  

Description	Color	Cat No.	Cat. No.
NEMA			
		5-15R	5-20R
Rating		Switch: 15A-120VAC	
		Receptacle: 15A-125V	
Single Pole Switch/ Tamper-Resistant Receptacle	White	T5625-W	
	Ivory	T5625-I	
	Almond	T5625-A	
	Light Almond	T5625-T	
	Grey	T5625-GY	
	Brown	T5625-E	
Single Pole Switch/Receptacle	White	5625-W	5636-W
	Ivory	5625-I	5636-I
	Almond	5625-A	5636-A
	Light Almond	5625-T	—
	Grey	5625-GY	—
	Black	5625-E	—
Rating		Switch: 15A-120VAC	Switch: 20A-120VAC
		Pilot Light: 1/25W-125VAC	Pilot Light: 1/25W-125VAC
Single Pole Switch/Pilot Light	White	5626-W	5637-W
	Ivory	5626-I	5637-I
	Almond	5626-A	5637-A

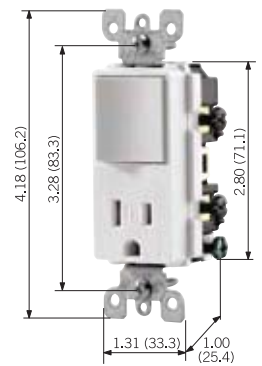

T5625-W

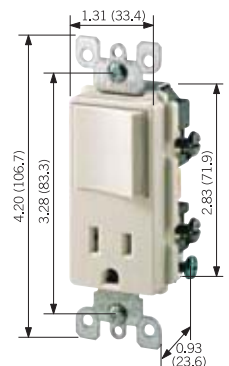

5625-W

Continued On Next Page >

Commercial Grade

Continued From Previous Page >

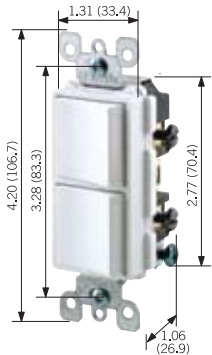

5634-W

Description	Color	Cat No.	Cat. No.
NEMA			
		5-15R	5-20R
Rating		15A-120/277VAC	20A-120/277VAC
Two Single Pole Switches	White	5634-W	5627-W
	Ivory	5634-I	5627-I
	Almond	5634-A	5627-A
	Light Almond	5634-T	5627-T
	Grey	5634-GY	—
	Black	5634-E	—
	Brown	5634	—
Rating		15A-120/277VAC	
3-Way Switch/ Single Pole Switch	White	5641-W	
	Ivory	5641-I	
	Almond	5641-A	
	Light Almond	5641-T	
	Black	5641-E	
Two 3-Way Switches	White	5643-W	5640-W
	Ivory	5643-I	5640-I
	Almond	5643-A	5640-A
	Light Almond	5643-T	5640-T
Rating		Switch: 15A-120VAC	
		Receptacle: 15A-125V	
3-Way Switch/ Receptacle	White	5645-W	
	Ivory	5645-I	
	Almond	5645-A	
	Light Almond	5645-T	
	Black	5645-E	

*All with ground screw

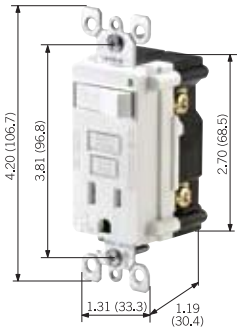

7299-W

Description	Color	Cat No.
Rating		Receptacle 15A-125V
		Feed-through: 20A-125V
		Switch Rating: 15A,
		1800W @ 120VAC
Single Pole Switch and Tamper Resistant SmartlockPro® GFCI-Protected Receptacle with Indicator Light	White	T7299-W
	Ivory	T7299-I
	Almond	T7299-A
	Light Almond	T7299-T
Single Pole Switch and SmartlockPro GFCI-Protected Receptacle with Indicator Light	White	7299-W
	Ivory	7299-I
	Almond	7299-A
	Light Almond	7299-T

Description	Color	Cat No.
Rating		Receptacle 15A-125V Feed-through: 20A-125V
Automatic ON/OFF Sensor	White	T7591-W
LED Guidelight and Tamper Resistant	Ivory	T7591-I
SmartlockPro® GFCI-Protected	Almond	T7591-A
Receptacle with Indicator Light	Light Almond	T7591-T
Rating		Receptacle 15A-125V Feed-through: 20A-125V
Automatic ON/OFF Sensor	White	7591-W
LED Guidelight and SmartlockPro	Ivory	7591-I
GFCI-Protected Receptacle	Almond	7591-A
with Indicator Light	Light Almond	7591-T



7591-W

DECORA® COMBINATION SWITCHES†

Description	Color	Cat No. non-grounded	Cat. No. with ground screw
Rating		Individual Switches: 15A-120V Device Total: 20A-120V	Individual Switches: 15A-120V Device Total: 20A-120V
Dual Rockers	White	1754-W	1754-2W
	Ivory	1754-I	—
	Almond	1754-A	—
	Light Almond	1754-T	—
Illuminated	White	1754-ILW	—
Dual Rockers	Ivory	1754-ILI	—
(Light is ON when top rocker is OFF)	Almond	1754-LA	—
Three Rockers	White	1755-W	1755-2W
	Ivory	1755-I	1755-2I
	Almond	1755-A	—
	Light Almond	1755-T	—

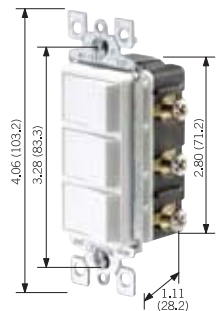

1755-W

†Warning: Although each individual rocker switch is rated up to 15A-120V, the total combined load for both duplex or all three triplex switches must not exceed 20 AMPS.

TESTING AND CODE COMPLIANCE

Decora Combination Switches

- UL Listed (File #E-7458)
- CSA Certified (File #LR-3413)
- NOM Certified (#057)

Switch/SmartlockPro GFCI Receptacle

- Meets or exceeds all new UL requirements for July 28, 2006
- UL Standard 943 Class A (GFCI) and 498 (Receptacles), 20 (Switches)
- UL Listed (File # E-48380)
- CSA Certified (File #LR-57811)
- NOM Certified (File #057)

MATERIAL CHARACTERISTICS

Decora Combination Switches

Environmental: Flammability UL-94, V2 Rating
Operating Temperature: -40°C to 120°C

Switch/SmartlockPro GFCI Receptacle

Environmental: Flammability UL-94 V2 Rating
Operating Temperature: -35°C to 65°C

Commercial Grade

Traditional

Leviton's Combination Devices offer pleasing, practical designs that fit standard wallboxes. Switch/switch, switch/receptacle and switch/pilot light combinations are available. These devices come in a range of colors and are backed by a limited two-year warranty.

Specifications and Features

- AC quiet switches have silver-cadmium oxide contacts and receptacles have double-wire contacts for maximum conductivity
- All devices have a grounding screw, except where noted
- Terminal screws accept up to No. 12 AWG copper or copper-clad wire
- Fits standard wallboxes
- Break-off tabs on devices with switches permit conversion to separate feeds
- Limited Two-Year Warranty

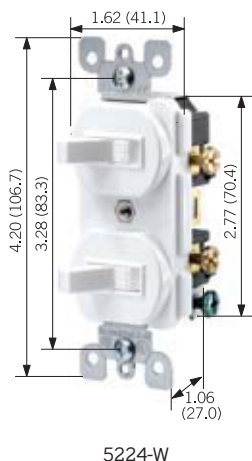
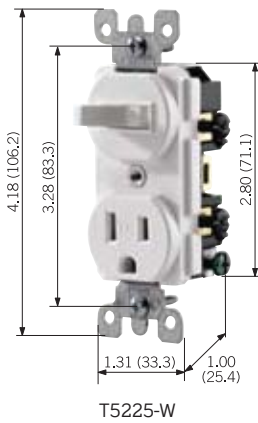

Tamper Resistant Receptacles

- Shutter mechanism inside the receptacle blocks access to the contacts unless a two-prong plug is inserted, helping ensure hairpins, keys, etc., will be locked out
- TR symbol on residential receptacles assures they meet the 2008 NEC requirement
- Heavy-duty construction offers long, trouble-free service life



COMBINATION DEVICES

Description	Color	Cat No.	Cat. No.
NEMA			
		5-15R	5-20R
Rating		Switch: 15A-120VAC	
		Receptacle: 15A-125V	
Single Pole Switch/ Tamper Resistant Receptacle*	White	T5225-W	
	Ivory	T5225-I	
	Almond	T5225-A	
	Light Almond	T5225-T	
	Brown	T5225	
Rating		Switch: 15A-120VAC	Switch: 20A-120VAC
		Receptacle: 15A-125V	Receptacle: 20A-125V
Single Pole Switch/Receptacle*	White	5225-W	5335-W
	Ivory	5225-I	5335-I
	Almond	5225-A	—
	Light Almond	5225-T	—
	Black	—	5335-E
	Brown	5225	5335
Rating		15A-120/277VAC	
Two Single Pole Switches, non-ground	White	5224-W	
	Ivory	5224-I	
	Brown	5224	
Rating		15A-120/277VAC	20A-120/277VAC
Two Single Pole Switches, with ground screw	White	5224-2W	5334-W
	Ivory	5224-2I	5334-I
	Almond	5224-2A	—
	Light Almond	5224-2T	—
	Brown	5224	5334

Description	Color	Cat No.	Cat. No.
NEMA		 5-15R	 5-20R
Rating		Switch: 15A-120VAC Pilot Light: 1/25W-125VAC	Switch: 20A-120VAC Pilot Light: 1/25W-125VAC
Single Pole Switch/Pilot Light*	White	5226-W	—
	Ivory	5226-I	5336-I
	Almond	5226-A	—
	Light Almond	5226-T	—
	Brown	5226	5336
Rating		15A-120/277VAC	
3-Way Switch/Single Pole Switch *	White	5241-W	—
	Ivory	5241-I	—
	Almond	5241-A	—
	Light Almond	5241-T	—
	Brown	5241	—
Rating		15A-120/277VAC	
Two 3-Way Switches*	White	5243-W	—
	Ivory	5243-I	—
	Almond	5243-A	—
	Light Almond	5243-T	—
	Brown	5243	—
Rating		Switch: 15A-120/277VAC Receptacle: 15A-125V	
3-Way Switch/Receptacle*	White	5245-W	—
	Ivory	5245-I	—
	Brown	5245	—

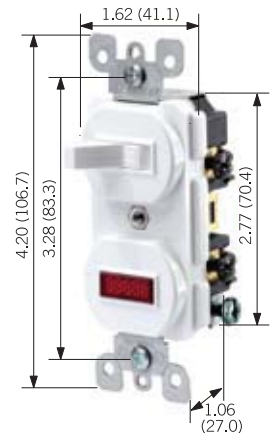

5226-W

*With ground screw

TESTING AND CODE COMPLIANCE

- UL Listed (File #E-7458)
- CSA Certified (File #LR-3413)
- NOM Certified (#057)

HORSEPOWER

15A — 1/2 @ 120V, 2 @ 240V
20A — 1 @ 120V, 2 @ 240V

MATERIAL CHARACTERISTICS

Environmental: Flammability UL-94, V2 Rating
Operating Temperature: -40°C to 120°C

Commercial Grade

DIMENSIONS

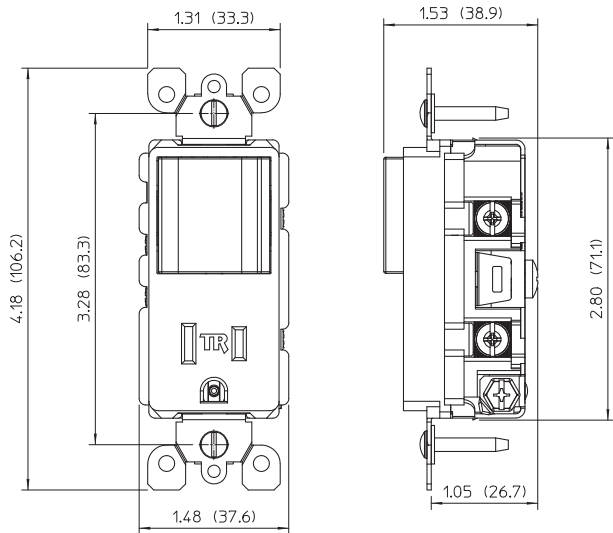

T5625 — Decora® Tamper Resistant Combination Switch/Receptacle

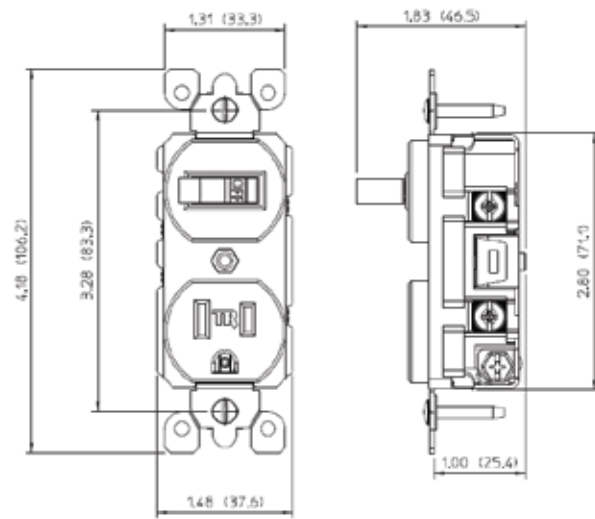

T5225 — Traditional Tamper Resistant Combination Switch/Receptacle

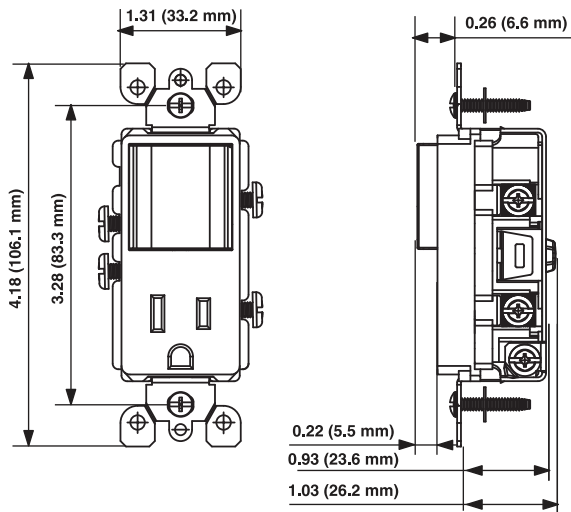

5625 — Decora® Combination Switch/Receptacle

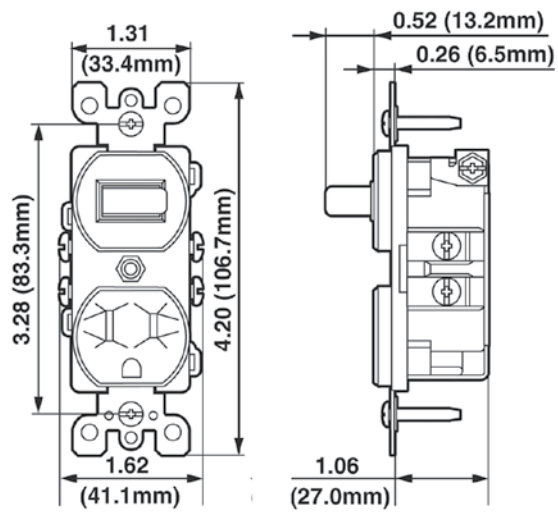

5225 — Traditional Combination Switch/Receptacle

Decora® LED Sensor Guide Lights

Our new LED Sensor Guide Light Series unites Leviton's quality Decora wiring devices with energy-saving LED Guide Lights for a smart combination. The Sensor LEDs turn ON and OFF automatically in Switch/Guide Light or Tamper-resistant Receptacle/Guide Light combinations, as well as a full LED Guide Light version that's perfect for hallways or stairways.

Specifications and Features

All Devices

- Impact-resistant face and body
- Long-lasting energy-efficient LED with long life expectancy — no bulbs to replace
- Light sensor provides automatic ON/OFF features
- All devices have a self grounding clip
- Fits standard wall boxes
- Back or side wired

Tamper Resistant Receptacle/Guide Light

- Uses two LEDs
- Shutter mechanism inside the receptacle blocks access to the contacts unless a two-prong plug is inserted, helping ensure foreign objects will be locked out
- Complies with section 406.11 of the 2008 NEC Code

Combination Switch/Guide Light

- Uses two LEDs
- Single Pole
- Neutral Required

Full LED Guide Light

- Uses three LEDs
- Color Change Kits available for select models

COLORS

Decora devices are offered in a wide range of colors and finishes. To order colors, add suffix to Cat No.



White
(-W)



Ivory
(-I)



Almond
(-A)



Light Almond
(-T)

Residential Grade

DECORA® COMBINATION DEVICES*

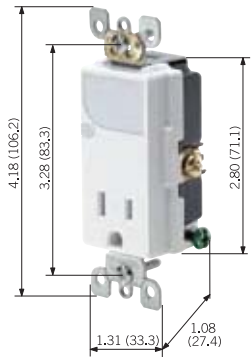

T6525

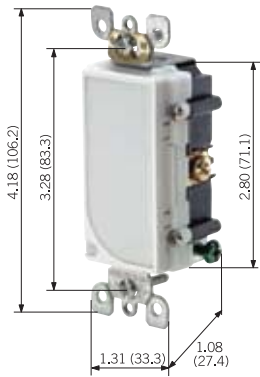

6527

Description	Color	Cat No.
NEMA		
		5-15R
Rating		15A-125VAC
Decora Tamper Resistant Receptacle/LED Guide Light	White	T6525-W
	Ivory	T6525-I
	Almond	T6525-A
	Light Almond	T6525-T
Rating		15A-125VAC
Decora Single Pole Switch/LED Guide Light	White	6526-W
	Ivory	6526-I
	Almond	6526-A
	Light Almond	6526-T
Rating		1W-120VAC
Decora Full LED Guide Light	White	6527-W
	Ivory	6527-I
	Almond	6527-A
	Light Almond	6527-T

TESTING AND CODE COMPLIANCE

- UL Listed (File #E-7458)
- CSA Certified (File #LR-341.3)
- NOM Certified (#057)

MATERIAL CHARACTERISTICS

Environmental: Flammability UL-94, V2 Rating
 Operating Temperature: -40°C to 120°C

HORSEPOWER

- 15A — 1/2 @ 120V

DIMENSIONS

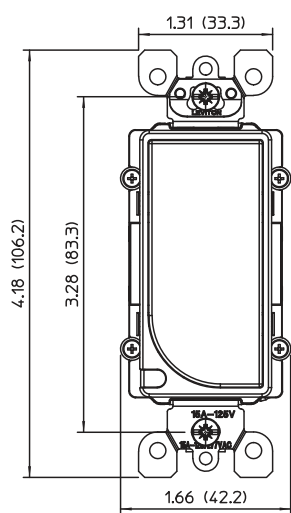

Decora 6527
Full LED Guidelight

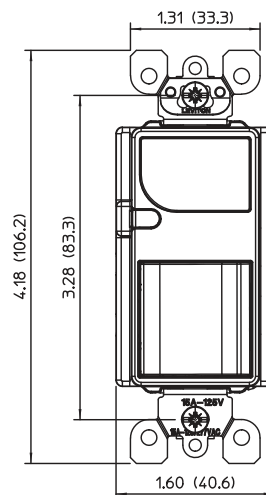
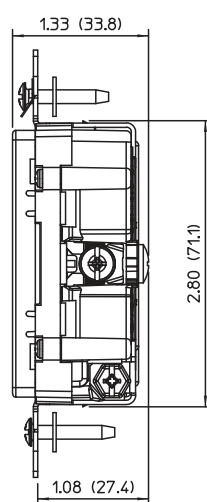

Decora 6526
Switch LED Guidelight

