

Do you want to simplify the sensor integration in your conveyor systems?

New XUY roller sensors for packet, boxes, letters on roller conveyors.



Telemecanique Sensor's **OsiSense™ XUY** photoelectric sensors are really innovative for fast and smart integration in conveyor systems.

Fast, modular & best installation time:

The sensor is mounted between rollers from the top. No more missing screws to mount your bracket and sensor.

Plug & Play : to see any package, no color effect, and no environment teaching.

Dust protection : special lenses and LED power to avoid dust accumulation

Impact resistant: unique mechanical installation embedded within the conveyor frame to prevent product damage



Watch a video and see first hand how easy the XUY Roller Sensor is to mount and operate.

Full automation integration:

The sensor is compatible with zone controllers from current motorized roller manufacturers or with standard PLC platforms. Different connectors or cable wires are offered.

Typical areas of application:

- Detection of packet, boxes, pallets and letters of paper, carton or metallic material.

Well suited for use in:

- conveying for manufacturing facilities, warehouses, and retail distribution centers.



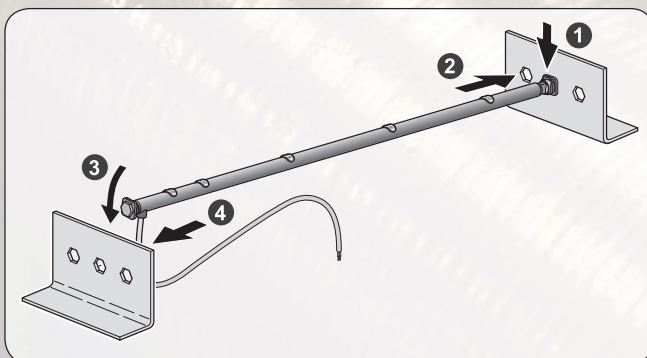
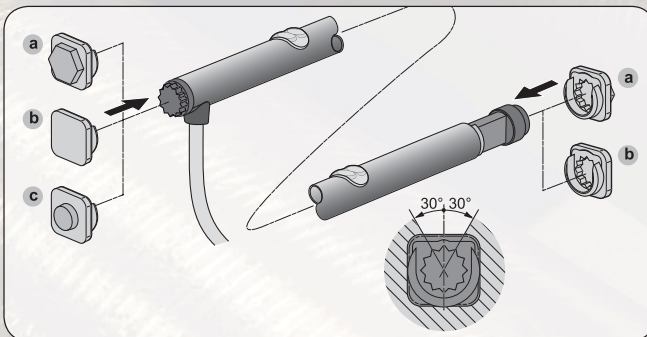
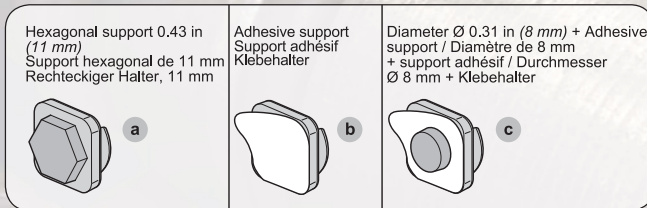
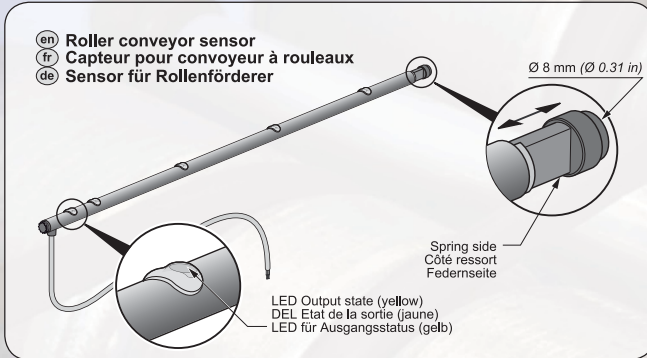
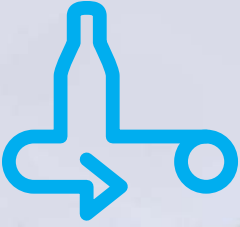

Benefits

Fast and simple installation:

- No tools needed
- Easy mounting from the top
- Gain of 50% in installation and adjustment
- 3 mounting solutions (Hexagonal 7/16", Ø 8 mm, or adhesive supports)

Full detection :

- No package color effecting sensor performance due to reliable infra-red sensing technology
- Easy direction adjustment, every 30°
- Full length detection from multiple sensors embedded within the sensor housing
- Convex lens to avoid dust accumulation

Characteristics

OsiSense™ XUY Roller Sensor

- Number of sensors: from 1 to 6 alongside the tube
- Detection mode: diffuse infrared
- Sensing distance up to 100 mm
- Dimension: Ø 12 mm, from 200 to 900 mm
- Material case / lens: aluminum / PMMA
- 3 mounting solutions with spring effect:
 - Hexagonal 7/16"
 - Ø 8 mm
 - Adhesive part
- Supply voltage: 24 V DC
- Connection: M12, 4 pins connector or cable
- Output: PNP/NPN, NO/NC programmable
- Switching frequency: 500 Hz
- Operating temperature: -10°C to to 50°C
- Degree of protection: IP 40 (IP 65 on request)

Please contact Telemecanique Sensors for other length of conveyor lengths (200 to 900mm)

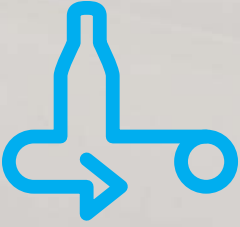

Product Specification

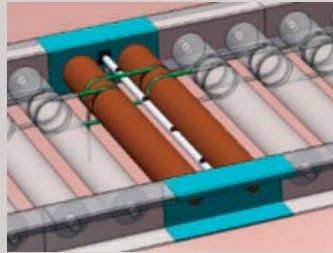

OsiSense™ XUY

XUY415N4HL2

XUY415N4HL03M12

Mechanical Characteristics:

Dimension (width)

Number of sensors

Diameter (case)

Sensor pitch

Connection

Mounting

Material

Case

Lens

roller conveyor sensor

PNP/NPN, NO/NC by cabling

cable 2m or remote M12 connector

415 mm, from 200 to 900 upon request

4 (number of sensors is determined by the overall conveyor width)

12mm

84 mm

M12 4 pins connector or cable

Hexagonal 7/16", Ø 8mm or adhesive

Aluminium and PA

PC

Detection performances:

Detection mode

Nominal sensing distance

Minimum object size

Maximum flow rate

Diffuse infrared

100 mm

85 mm

60 m/mn

Electrical Characteristics:

Voltage limits

Current consumption

Output LED

Switching capacity

Switching frequency

18 to 36 Volts DC (including ripples)

35 mA

yellow

100 mA with overload and short circuit protection

500 Hz

Environmental characteristics:

Operating temperature

IP class

-10°C to 50°C

IP40 (IP65 upon request)

XUY roller sensor conveyor

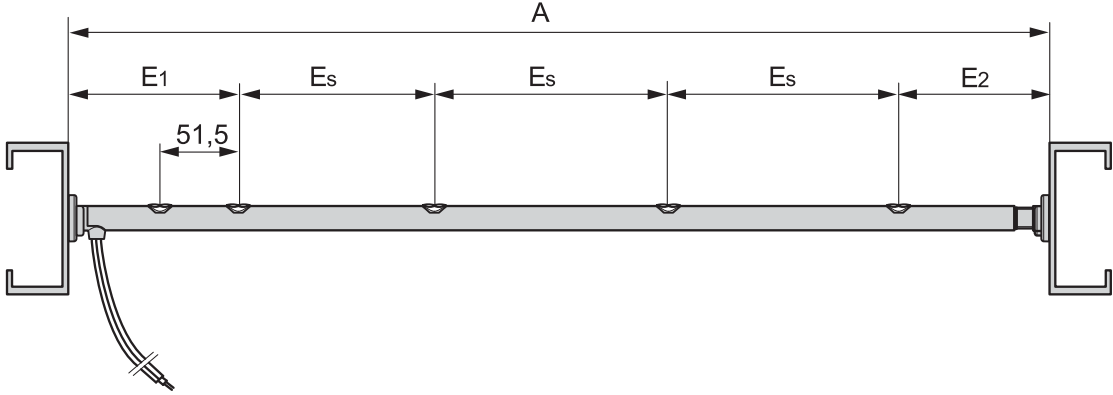

Catalog Number Configuration

XUY 415 N 4 H L2

Reference	A	# of Sensors	Es	E1	E2
XUY415N4HL2	415	4	84	100	63
	200-240	1	n.a.	100<E1<120	90<E2<120
	245-325	2	84		60<E2<120
	330-410	3			
	415-490	4			
	495-575	5	168	190<E1<210	60<E2<210
	580-660	6			
	665-755	3			
760-900	4				

Functions additional main (A..Z)		
	No Additional function	N
	Timer *	T
	ZPA function (zero pressure accumulation) *	Z

Mounting Style		
	Hexagonal 7/16"	H
	Adhesive part	A
	Diameter 8mm	D

Cabling	M 12x1 (D)	M	1	2			
Cabling material	Cable 0,3m	L	0	3			
Cabling length	Cable 2m	L	2				
	Cable 5m	L	5				
	Connector M 12 with 0,31 m cable	L	0	3	M	1	2

For this example, XUY415.. is available for any conveyor width from 414 to 418 mm (-1, +3 mm)

* Future capability. Call local field sales office for more information and availability.

Important Note: Not all configurations may be possible.

Photo-electric sensors

OsiSense XU Application, conveying series
For detecting packages on a roller conveyor
DC supply, solid-state output

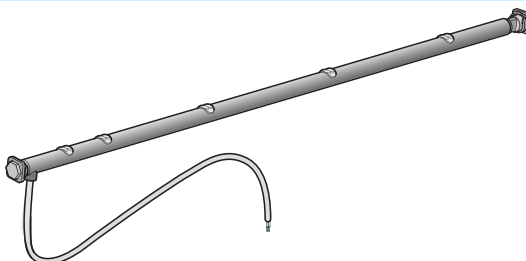

Nominal sensing distance (Sn)	0.1 m	
Function	NO/NC programmable	
Connection	PNP + NPN	
Cabling	Pre-cabled, L = 2 m	Remote M12 connector, L = 0.3 m

References

4-wire	XUY 415N4HL2 (1)	XUY 415N4HL03M12 (1)
Weight (kg)	0.075	0.065

Characteristics

Product certifications	CE	
Type of transmission	Infrared	
Operating mode	Diffuse	
Nominal sensing distance	100 mm (white paper)	
Differential travel	< 25%	
Degree of protection	Conforming to IEC 60529	IP 40 (IP 65 on request)
Ambient air temperature	For operation	- 10... + 55°C
	For storage	- 20... + 80°C
Vibration resistance	Conforming to EN/IEC 60068-2-8	For X, Y and Z: 1 mm from 10 to 42 Hz 7 gn from 42 to 55 Hz 30 mm at resonant frequency or 55 Hz
	Conforming to EN/IEC 60068-2-27	For X, Y and Z: 10 gn for 11 ms
Material	Case	Aluminium and PA
	Lenses	PC
Rated supply voltage	24 V with protection against reverse polarity	
Voltage limits (including ripple)	18...30 V of rated operational voltage	
Switching capacity	100 mA with overload and short-circuit protection	
Voltage drop, closed state	≤ 2 V	
Power consumption	≤ 35 mA	
Maximum switching frequency	500 Hz	
Delay	1 ms response	
	1 ms recovery	
Indicator lights	Output state	1 yellow LED
Detection accuracy	2 mm at 2m/s	

References of accessories

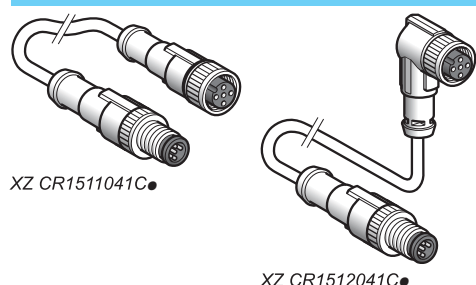

XZ CR1511041C●

XZ CR1512041C●

Designation	Length m	Reference	Weight kg
M12-M12 jumper cables			
4-pin, straight connector	1	XZ CR1511041C1	0.065
	2	XZ CR1511041C2	0.095
4-pin, elbowed connector	1	XZ CR1512041C1	0.065
	2	XZ CR1512041C2	0.095

(1) These sensors are adapted for use on a 414-418 mm wide conveyor frame (-1, + 3 mm).
Mounting accessory included with this sensor is for 7/16" hexagonal frame.
Please consult Sensor Competency Center for any additional sizes, configurations, mounting,
or other requirements.

Photo-electric sensors

OsiSense XU Application, conveying series

For detecting packages on a roller conveyor

DC supply, solid-state output

Connections

M12 connector



Pin n°/colour

- 1 BN: Brown
- 2 WH: White
- 3 BU: Blue
- 4 BK: Black

PNP + NPN

Programmable, NO or NC output

4-wire

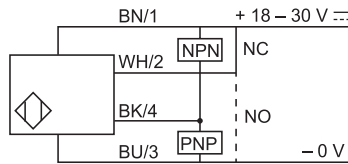

3-wire

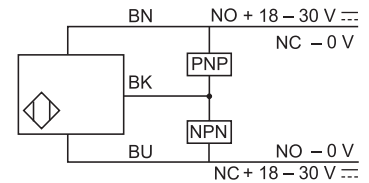

Dimensions (mm)

A	Sensor	Es	E1	E2
415	x 4	84	100	63
200...240	x 1	-	100 <E1<120	90 <E2<120
245...235	x 2	84		60 <E2<120
330...410	x 3			
415...490	x 4			
495...575	x 5			
580...660	x 6			
665...755	x 3	168	190 <E1<210	60 <E2<210
760...900	x 4			60 <E1<210

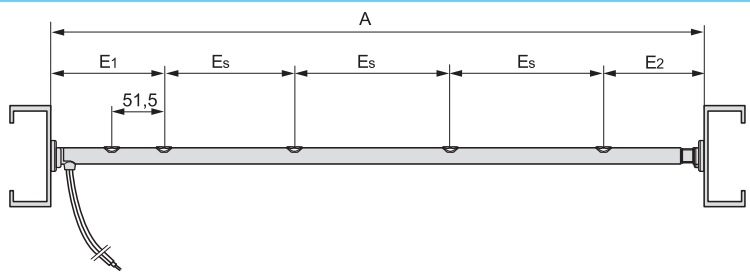

Mounting

Parts for mounting the sensor (included with the sensor)

7/16" (11 mm) hexagonal frame

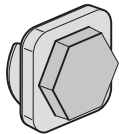

Adhesive frame



Ø 8mm frame, with adhesive mounting

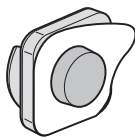

Mounting precautions

Recommended mounting

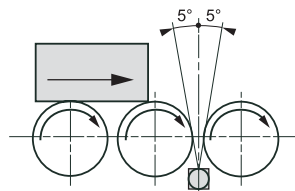
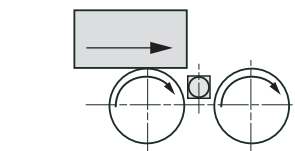
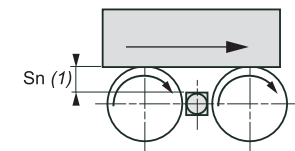

Not recommended

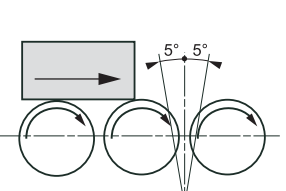
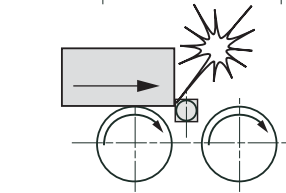
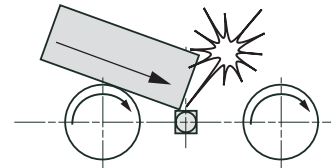

(1) $S_n \leq 100$ mm

Application example

Package detection - sensor mounted between motorized rollers

