

Data Sheet

PacDrive™ C400 / C400 A8 Controller

ETID 098 / 2009-05-05
Artikel Nr.: 17130202-001

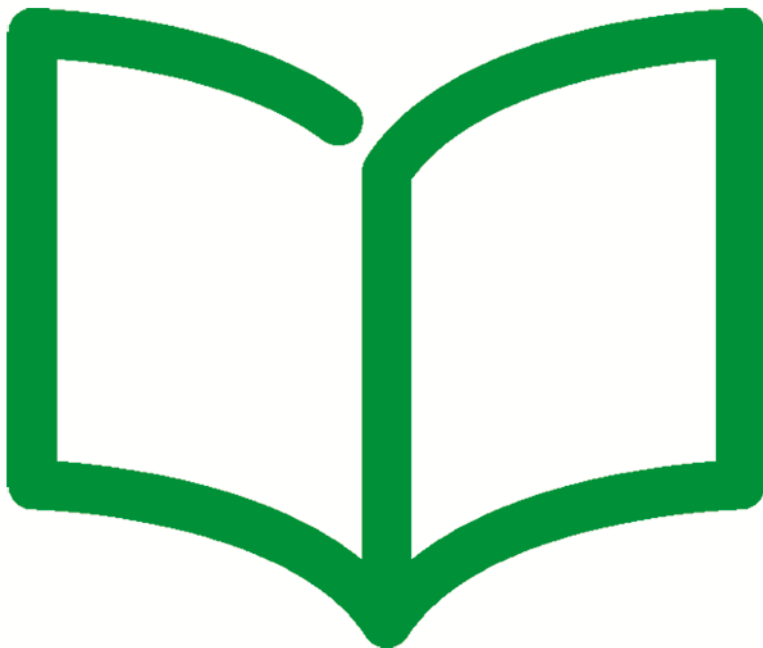

Legal notice

© All rights reserved to ELAU GmbH, also in case of patent right applications. No part of this documentation or the accompanying software and firmware may be reproduced, transferred, paraphrased, saved to a storage medium or translated to another language or computer language without the written consent of ELAU GmbH. Any possible measure was taken to ensure that this product documentation is complete and correct. However, since hardware and software are continuously improved, ELAU makes no representations or warranties with respect to the contents of this documentation.

All information on our products in this manual are given purely for the purpose of product description and is not binding. Misprints, errors and modifications -without prior notice in the course of product development- are reserved. If details contained in this manual are explicitly a part of an agreement made with ELAU GmbH, then the details of the agreements in this manual are exclusively to determine the agreed condition of the object of agreement, on behalf of the § 434 BGB (condition guarantee on behalf of legal regulations).

Trademark

PacDrive is a registered trademark of ELAU GmbH.
All other trademarks mentioned in this documentation are the exclusive property of their manufacturers.

ELAU GmbH
Dillberg 12-16
97828 Marktheidenfeld, Germany

Tel.: +49 (0) 9391 / 606 - 0
Fax: +49 (0) 9391 / 606 - 300

E-mail: info@elau.de
Internet: www.elau.de

1 Overview

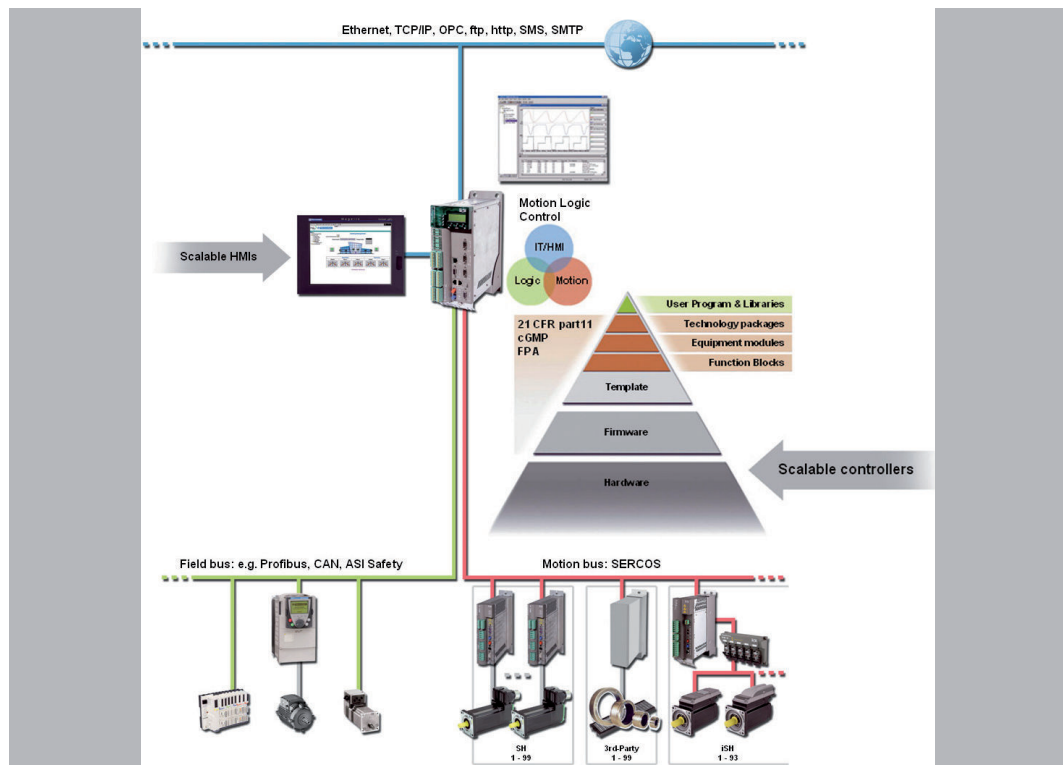

Figure 1-1: PacDrive System Overview

C400 / C400 A8 Controller

Controller based architecture

The PacDrive C400 Controller is based on an Intel module processor. It uses the real-time operating system VxWorks. VxWorks provides logic and motion functions for a production or packaging machine. A PacDrive Controller synchronizes, coordinates and generates the positioning functions for up to 16 servo drives, which are connected via the SERCOS bus interface.

Several standardized field bus interfaces are available: PROFIBUS DP, CAN, CAN-open or DeviceNet. A variety of standard HMI systems, ranging from low-cost text displays to industrial PCs, can be used for the HMI functions.

- CPU: Intel Module, 600 MHz, 256 MB RAM
- Real-Time operating system: VxWorks
- IEC 61131-3 programming languages for PLC and Motion Control
- SERCOS interface
- Profibus DP, CAN, CANopen, DeviceNet, or Ethernet/IP
- Digital inputs, digital outputs, analog, interrupt and Touchprobe inputs
- Communication interfaces: RS 232, RS 485, Ethernet (TCP/IP)
- CompactFlash™ card (≥128 MB)
- Includes OPC server for Windows-based HMIs
- Teleservice via web server or modem

2 Technical data

2.1 Ambient conditions

Procedure	Parameters	Value	Basis
Operation	Class 3K3		IEC/EN 60721-3-3
	Ambient temperature	+5°C...+45°C	
	Condensation	Prohibited	
	Icing	Prohibited	
	Another water	Prohibited	
	Relative humidity	5% ... 85%	
Transport	Class 2K3		IEC/EN 60721-3-2
	Ambient temperature	-25°C...+70°C	
	Condensation	Prohibited	
	Icing	Prohibited	
	Another water	Prohibited	
	Relative humidity	5% ... 95%	
Long time storage in transport packaging	Class 1K4		IEC/EN 60721-3-1
	Ambient temperature	-25°C...+55°C	
	Condensation	Prohibited	
	Icing	Prohibited	
	Another water	Prohibited	
	Relative humidity	5% ... 95%	

Table 2-1: Ambient conditions PacDrive C400 Controller

Procedure	Parameters	Value	Basis
Operation	Class 3K3		IEC/EN 60721-3-3
	Ambient temperature	+5°C...+40°C	
	Condensation	Prohibited	
	Icing	Prohibited	
	Another water	Prohibited	
	Relative humidity	5% ... 85%	
Transport	Class 2K3		IEC/EN 60721-3-2
	Ambient temperature	-25°C...+50°C	
	Condensation	Prohibited	
	Icing	Prohibited	
	Another water	Prohibited	
	Relative humidity	5% ... 95%	
Long time storage in transport packaging	Class 1K3		IEC/EN 60721-3-1
	Ambient temperature	-5°C...+45°C	
	Condensation	Prohibited	
	Icing	Prohibited	
	Another water	Prohibited	
	Relative humidity	5% ... 95%	

Table 2-2: Ambient conditions PacDrive C400 Controller (with UPS)

2.2 Standards and regulations

Certifications	CE, UL , cUL
----------------	--------------

Table 2-3: Standards and regulations PacDrive C400 Controller

2.3 Mechanical and electrical data

Category	Parameters	Value
Product configuration	Type key C400 up to 16 SERCOS slaves (SERCOS slaves = MC-4, SCL, iSH)	PacDrive C400 / 10 / 1 / 1 / 1 / 00
	Type key C400 up to 8 SERCOS slaves	PacDrive C400 / A8 / 1 / 1 / 1 / 00
	Order number- C400 up to 16 SERCOS slaves	13 13 02 61
	Order numbers C400 up to 8 SERCOS slaves	13 13 02 61-001
Processor	CPU	C400 up to 16 SERCOS slaves: Intel Pentium M 600 MHz C400 up to 8 SERCOS slaves: Celeron M 600 MHz
	RAM	256 MB
	L2 Cache	C400 up to 16 SERCOS slaves: 1 MB C400 up to 8 SERCOS slaves: 512 kB
	NVRAM	128 kB
	CompactFlash™ card	≥128 MB
	Real time clock (RTC)	Yes (battery maintenance interval: 5 years)
	Watchdog	Yes (max. 60 V < 2 A)
	Diagnosis	Alphanumeric diagnostic display, Status LEDs
Operating system	Real-time operating system	VxWorks
Programming languages	Programming languages IEC 61131-3	Instruction list (IL)
		Ladder diagram (LD)
		Function block diagram (FBD)
		Sequential function chart (SFC)
		Structured text (ST)
		Continuous function chart (CFC)

Category	Parameters	Value
Interfaces	Serial interfaces	COM1: RS232 (X17) COM2: RS485 (X18)
	Network connection	Ethernet (10/100 Base-T) (X10)
	Field bus connections	PROFIBUS DP Master/Slave (12 MBaud) (X20) or CAN (2.0A) or CANopen (X19)
		DeviceNet Slave (cable adapter required)
		EtherNet/IP Slave (projected) (optional hardware module required)
	Real-time bus interface	SERCOS interface (16 MBaud) (X14, X15)
	PacNet interface	2 PacNet interfaces (X12, X13)
	Master encoder interfaces	1 SinCos master encoder or
		1 incremental master encoder (X11)
	HMI Interfaces	RS485 (Modbus or PROFIBUS DP)
		HMI software tools: OPC server (for Windows NT/2000/XP or Windows CE)
	Diagnostic interface for remote maintenance	Modem
	Communications protocols	Http
		Ftp
SMTP (E-Mail)		
Integrated trace recorder (software oscilloscope)	8 channels, resolution 1 ms	
Integrated data logger for diagnostic messages	27 kB	
Output	C400	16 servo axes with all SERCOS cycle times
	C400 / A8	8 servo axes with all SERCOS cycle times Max. of 255 parallel motion profiles possible
SPS output	Time for 1000 Bit instructions	7 μ s
	Number of PLC processes	Unlimited
	Type of PLC processes	Continuous, periodic or event-controlled
		Cycle time fast task
	nominal I/O response time	500 μ s (read in data, process, set output)
Cam Switch Group	Number of cams	Max. 256
	Sequential circuit	Dynamic
	Outputs	Memory or Digital outputs
		Inputs
	Virtual master encoder	
Axis position		
Processing time	250 μ s	
Digital inputs (X3)	Number	20 (IEC61131-2)
	Range $U_{IN 0}$ Voltage	DC 0 ... 6 V
	Range $U_{IN 1}$ Voltage	DC 20 ... 33 V
	Input data	$I_{IN} = 5 \text{ mA}$ by $U_{IN} = 24 \text{ V}$
	Polarized	Yes
	Input filter	1 or 5 ms can be parameterized

Category	Parameters	Value
Analog inputs (X5)	Number	2
	Range U_{IN}	-10 ... 10 V
		Resolution 12 Bit (5 mV)
		Resistor 100 kOhm
	Range I_{IN}	-20 ... 20 mA
		Resolution 12 Bit, (5 μ A)
Resistor 500 Ohm		
Interrupt inputs (X4)	Number:	4 (IEC61131-2)
	Range U_{IN} 0 Voltage	DC 0 ... 6 V
	Range U_{IN} 1 Voltage	DC 20 ... 33 V
	Input data	$I_{IN} = 5$ mA by $U_{IN} = 24$ V
	Polarized	Yes
	Input filter	0.1 or 1 ms can be parameterized
Touchprobe inputs (X4)	Number	16 (IEC61131-2)
	Range U_{IN} 0 Voltage	DC 0 ... 6 V
	Range U_{IN} 1 Voltage	DC 20 ... 33 V
	Input data	$I_{IN} = 5$ mA by $U_{IN} = 24$ V
	Polarized	Yes
	Input filter TP0 to TP15	100 μ s resolution
	TP0 to TP15	10 μ s at a cycle time of 1, 2, 4 ms
Digital outputs (X2)	Number	16 (IEC61131-2)
	Output voltage	$(+UL-3$ V) < U_{OUT} < +UL
	Rated current	$I_e = 250$ mA per output
	Inrush current	$I_{emax} < 2$ A for 1 s
	Leakage current with 0 signal	< 0.4 mA
	Transmission time	100 μ s
	short circuit proof	Yes
Digital outputs (X5)	Number	2
	Range U_{OUT}	-10 ... 10 V
	Resolution	12 Bit (5 mV)
	Load	> 5 kOhm (max. Offset < +/- 75mV)
Additional digital and analog I/Os	Via field bus	Max. 3,584 bytes digital/analog inputs and Max. 3,584 bytes digital/analog outputs Max. number of stations: 126 (PROFIBUS)
	Additional fast digital I/Os	Via PacNet Max. 128 inputs and 128 outputs
	Additional Touchprobe inputs	Via PacNet Max. 128 Touchprobe inputs
Power supply	Power supply unit	DC 24 V (-15% / +25%)
		max. 3,0 A without UPS
		max. 4,5 A without UPS
	Power consumption	Max. 85 W
Uninterruptible Power Supply (UPS)	Internal, optional (maintenance interval 3 years)	
Dimensions	Dimensions packaging	DxWxH (mm): 300x130x400
Weight	Weight (with packaging)	3.5 kg (4.1 kg)
Protection class	Housing	IP 20

Category	Parameters	Value
Isolation class	Degree of pollution	2

Table 2-4: Technical data PacDrive C400 Controller

2.4 Electrical connections

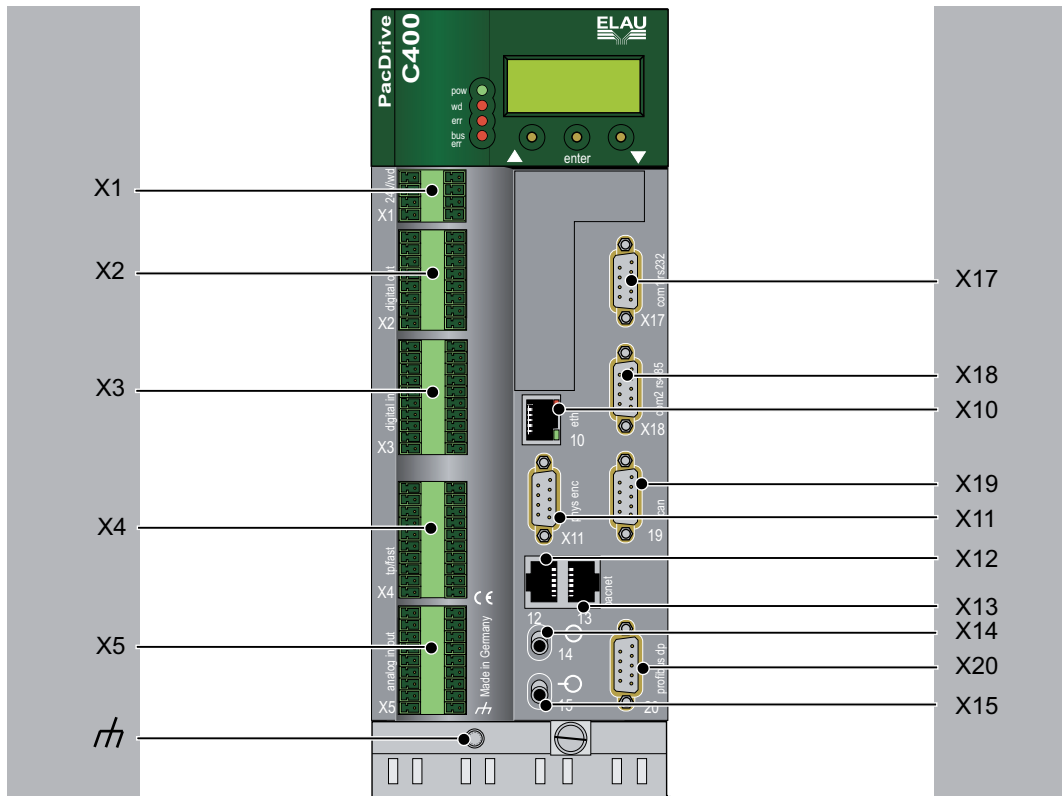

Figure 2-1: Connection overview PacDrive C400 Controller

Connection	Meaning	max. terminal cross-section [mm ²]/ [AWG]	
X1	Control voltage/ Watchdog	1.50 mm ²	28 - 16
X2	Digital outputs	1.50 mm ²	28 - 16
X3	Digital inputs	1.50 mm ²	28 - 16
X4	Touchprobe and fast digital inputs	1.50 mm ²	28 - 16
X5	Analog inputs/outputs	1.50 mm ²	28 - 16
X10	Ethernet connection	-	-
X11	Master encoder (SinCos)	0.25 mm ²	-
X11	Master encoder (incremental)	0.25 mm ²	-
X12/X13	PacNet	-	-
X17	Com 1 (RS232)	0.25 mm ²	-
X18	Com 2 (RS485)	0.25 mm ²	-
X19	CAN	0.25 mm ²	-
X20	PROFIBUS db	0.25 mm ²	-
rh	Shielded connector	-	-

Table 2-5: Connection overview PacDrive C400 Controller

X1 - Control voltage and watchdog



Pin	Designation	Meaning	Range
1	DC +24 V	Supply voltage	- 15 % / +25 %
2	DC 0 V	Supply voltage	
3	+UL	For digital outputs	DC +24 V -15 % / +25 %
4	L0	For digital inputs/outputs	
5	DC +24 V	Supply voltage (with pin 1 bridged, max. ampacity 4A)	-15 % / +25 %
6	DC 0 V	Supply voltage (with pin 2 bridged, max. ampacity 4A)	
7	WD	Watchdog relay	
8	WD	Watchdog relay	

Table 2-6: Connection X1

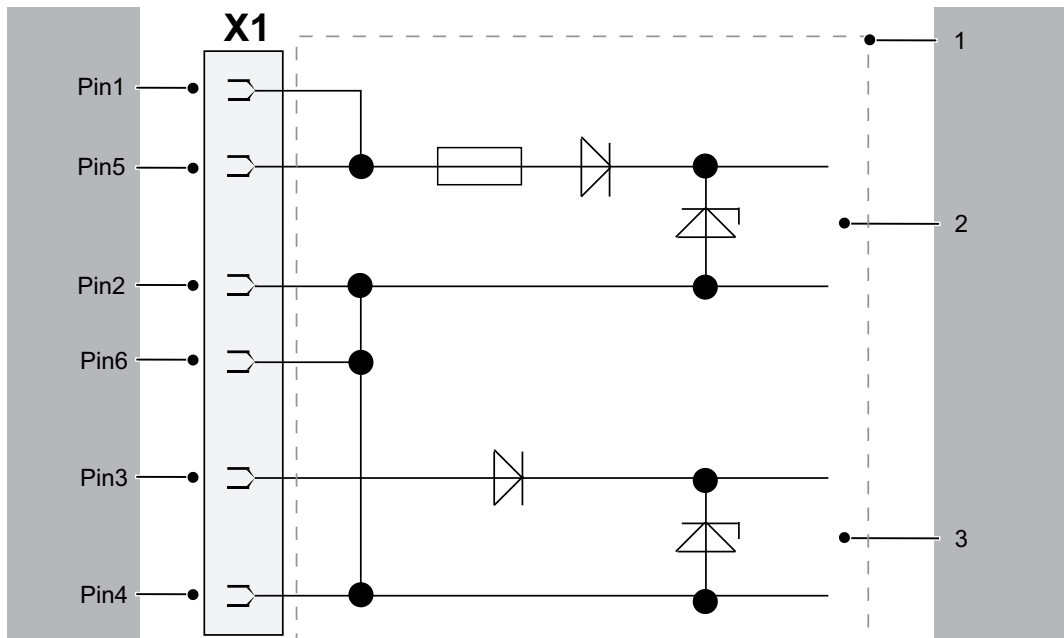
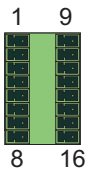

Figure 2-2: Connection X1 - Input connection

1	Internal wiring diagram - input connection of power supply (simplified)
2	Internal supply voltage
3	Supply voltage for digital outputs/inputs

X2 - Digital outputs



Pin	Designation	Meaning	Range
1	O.00	Digital output 1	DC 20 ... 30 V
2	O.01	Digital output 2	DC 20 ... 30 V
3	O.02	Digital output 3	DC 20 ... 30 V
4	O.03	Digital output 4	DC 20 ... 30 V
5	O.04	Digital output 5	DC 20 ... 30 V
6	O.05	Digital output 6	DC 20 ... 30 V
7	O.06	Digital output 7	DC 20 ... 30 V
8	O.07	Digital output 8	DC 20 ... 30 V
9	O.08	Digital output 9	DC 20 ... 30 V
10	O.09	Digital output 10	DC 20 ... 30 V
11	O.10	Digital output 11	DC 20 ... 30 V
12	O.11	Digital output 12	DC 20 ... 30 V
13	O.12	Digital output 13	DC 20 ... 30 V
14	O.13	Digital output 14	DC 20 ... 30 V
15	O.14	Digital output 15	DC 20 ... 30 V
16	O.15	Digital output 16	DC 20 ... 30 V

Table 2-7: Connection X2

X3 - Digital inputs

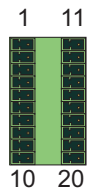

Pin	Designation	Meaning	Range
1	I.00	Digital input 0	DC 20 ... 30 V
2	I.01	Digital input 1	DC 20 ... 30 V
3	I.02	Digital input 2	DC 20 ... 30 V
4	I.03	Digital input 3	DC 20 ... 30 V
5	I.04	Digital input 4	DC 20 ... 30 V
6	I.05	Digital input 5	DC 20 ... 30 V
7	I.06	Digital input 6	DC 20 ... 30 V
8	I.07	Digital input 7	DC 20 ... 30 V
9	I.08	Digital input 8	DC 20 ... 30 V
10	I.09	Digital input 9	DC 20 ... 30 V
11	I.10	Digital input 10	DC 20 ... 30 V
12	I.11	Digital input 11	DC 20 ... 30 V
13	I.12	Digital input 12	DC 20 ... 30 V
14	I.13	Digital input 13	DC 20 ... 30 V
15	I.14	Digital input 14	DC 20 ... 30 V
16	I.15	Digital input 15	DC 20 ... 30 V
17	I.16	Digital input 16	DC 20 ... 30 V
18	I.17	Digital input 17	DC 20 ... 30 V
19	I.18	Digital input 18	DC 20 ... 30 V
20	I.19	Digital input 19	DC 20 ... 30 V

Table 2-8: Connection X3

X4 - Touchprobe and fast digital inputs

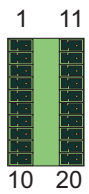

Pin	Designation	Meaning	Range
1	T.00	Touchprobe input 0	DC 20 ... 30 V
2	T.01	Touchprobe input 1	DC 20 ... 30 V
3	T.02	Touchprobe input 2	DC 20 ... 30 V
4	T.03	Touchprobe input 3	DC 20 ... 30 V
5	T.04	Touchprobe input 4	DC 20 ... 30 V
6	T.05	Touchprobe input 5	DC 20 ... 30 V
7	T.06	Touchprobe input 6	DC 20 ... 30 V
8	T.07	Touchprobe input 7	DC 20 ... 30 V
9	T.08	Touchprobe input 8	DC 20 ... 30 V
10	T.09	Touchprobe input 9	DC 20 ... 30 V
11	T.10	Touchprobe input 10	DC 20 ... 30 V
12	T.11	Touchprobe input 11	DC 20 ... 30 V
13	T.12	Touchprobe input 12	DC 20 ... 30 V
14	T.13	Touchprobe input 13	DC 20 ... 30 V
15	T.14	Touchprobe input 14	DC 20 ... 30 V
16	T.15	Touchprobe input 15	DC 20 ... 30 V
17	F.00	Fast input 1	DC 20 ... 30 V
18	F.01	Fast input 2	DC 20 ... 30 V
19	F.02	Fast input 3	DC 20 ... 30 V
20	F.03	Fast input 4	DC 20 ... 30 V

Table 2-9: Connection X4

X5 - Analog inputs/outputs

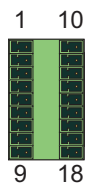

Pin	Designation	Meaning	Range
1	AI.0 +	Analog input 0+	-10 ... +10 V ^(*) 0 ... 20 mA ^(**)
2	J.0 +	Br. current input 0 +	
3	AI.0 -	Analog input 0-	
4	A.GND 0	Analog ground 0	
5	12 V Out 0	Output voltage 0	12 V
6	PE	Shield	
7	AO.0	Analog output 0	-10 ... +10 V
8	A.GND AO.0	Analog ground 0	
9	PE	Shield	
10	AI.1 +	Analog input 1+	-10 ... +10 V ^(*) 0 ... 20 mA ^(**)
11	J.1 +	Br. current input 1 +	
12	AI.1 -	Analog input 1-	
13	A.GND 1	Analog ground	
14	12 V Out 1	Output voltage 1	12 V
15	PE	Shield	
16	AO.1	Analog output 1	-10 ... +10 V
17	A.GND AO.1	Analog ground	
18	PE	Shield	

(*) Voltage metering and (**)current measurement on AI.0+ / AI.0- (Pin 1 / Pin 3) and AI.1+ / AI.1- (Pin 10 / Pin 12)
 (***)Current measurement by bridging to J.0+ (Pin 2) or. J.1+ (Pin 11).

Table 2-10: Connection X5

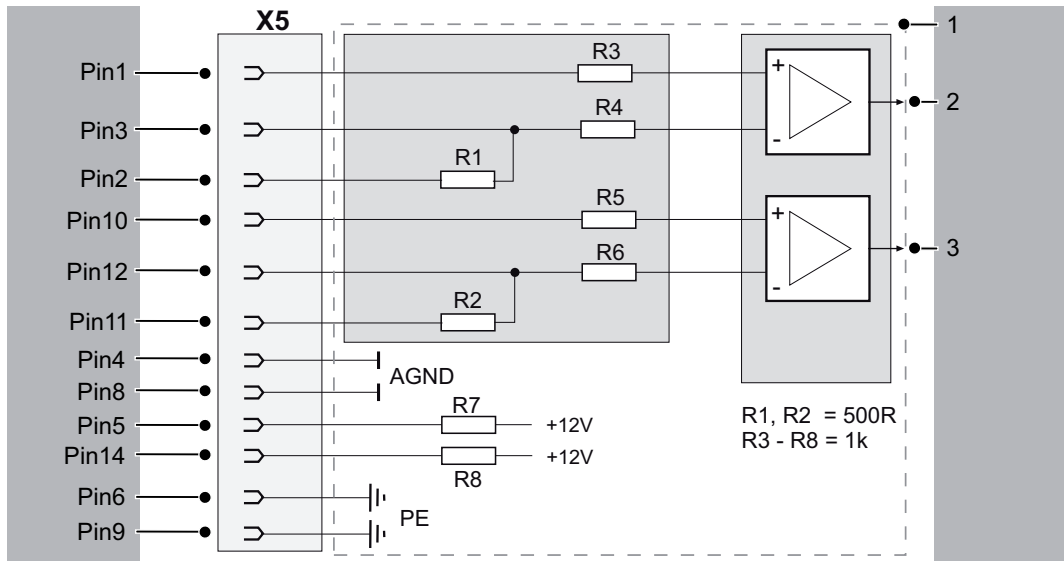
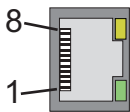

Figure 2-3: Connection X5 - Input connection

1	Internal wiring diagram - input connections for analog inputs (simplified)
2	Analog Input 1
3	Analog Input 2

X10 - Ethernet



Pin	Designation	Meaning	Range
1	Tx+	OutputTransmitData+	
2	Tx-	OutputTransmitData-	
3	Rx+	InputReceiveData+	
4	-	(PE)	
5	-	(PE)	
6	Rx-	InputReceiveData-	
7	-	(PE)	
8	-	(PE)	

Table 2-11: Connection X10



Depending on the application, you will need different cables to connect the controller via the RJ-45 outlet.

Component A	Component B	required cable
PacDrive Controller	"Firm network" with RJ-45	Commercially available patch cable
PacDrive Controller	Hub	Commercially available patch cable
PacDrive Controller	PC	Crossed RJ-45 network cable

- In case of doubt, ask your network administrator.

X11 - Master encoder (SinCos)

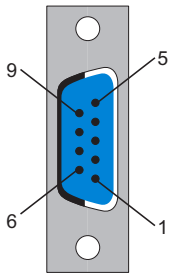

Pin	Designation	Meaning	Range
1	REFSIN	Reference Signal Sinus	
2	SIN	Sinus trace	
3	REFCOS	Reference Signal Cosinus	
4	COS	Cosinus trace	
5	+9 V	Supply voltage	
6	RS485-	Parameter channel -	
7	RS485+	Parameter channel +	
8	SC_SEL	Master encoder plugged in (bridge to GND)	
9	GND	Supply voltage	

Table 2-12: Connection X11 - Master encoder (SinCos)

X11 - Master encoder (incremental)

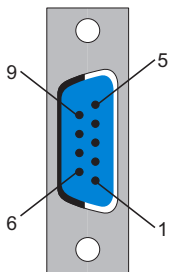

Pin	Designation	Meaning	Range
1	_UA	Track A	
2	UA	Track A	
3	_UB	Track B	
4	UB	Track B	
5	+5 V	Supply voltage	
6	_UO	Track O	
7	UO	Track O	
8	-	-	
9	GND	Ground	

Table 2-13: Connection X11 - Master encoder (incremental)

⚠ CAUTION

PLUGGING IN/UNPLUGGING THE MASTER ENCODER PLUG WHEN SWITCHED ON

- Only unplug or plug in master encoder when off-circuit.
- Disconnect controller from the 24 V supply voltage.

Failure to follow these instructions can result in equipment damage.

X12/13 - PacNet

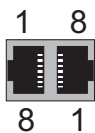

Pin	Designation	Meaning	Range
1	TxD+	OutputTransmitData+	
2	TxD-	OutputTransmitData-	
3	RxD+	InputReceiveData+	
4	TxC-	OutputTransmitClock-	
5	TXC+	OutputTransmitClock+	
6	RxD-	InputReceiveData-	
7	RxC+	InputReceiveClock+	
8	RxC-	InputReceiveClock-	

Table 2-14: Connection X12, X13



Use only approved PacNet cables at the PacNet connection to avoid malfunction.

X17 - Com 1 (RS 232)

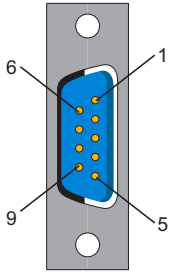

Pin	Designation	Meaning	Range
1	DCD	Data Carrier Detect	
2	RxD	Receive Data	
3	TxD	Transmit Data	
4	DTR	Data Terminal Ready	
5	GND	Signal Ground	
6	DSR	Data Set Ready Clear To Send	
7	RTS	Request To Send	
8	CTS	Clear To Send	
9	RI	Ring Indicator	

Table 2-15: Connection X17

X18 - Com 2 (RS485)

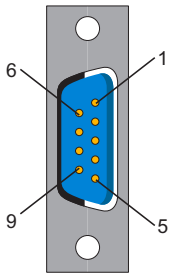

Pin	Designation	Meaning	Range
1	+5 VM	Supply voltage	
2	TxD-	RS485 Transmit -	
3	TxD+	RS485 Transmit+	
4	RxD+	RS485 Receive +	
5	RxD-	RS485 Receive -	
6	GNDR	GND receive RS485	
7	-	Reserved	
8	GNDM	Supply voltage	
9	GNDR	GND receive RS485	

Table 2-16: Connection X18

X19 - CAN

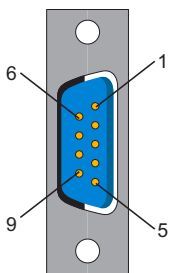

Pin	Designation	Meaning	Range
1	-	Reserved	
2	CAN_L	Bus line (low)	
3	GND	Ground	
4	-	Reserved	
5	-	Reserved	
6	-	Reserved	
7	CAN_H	Bus line (high)	
8	-	Reserved	
9	-	Reserved	

Table 2-17: Connection X19



An adapter is available for the connection to DeviceNet.

X20 - profibus db

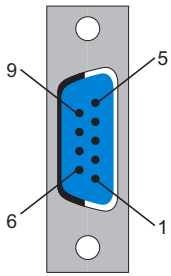

Pin	Designation	Meaning	Range
1	PE	Shield	
2	-	Reserved	
3	RxD / TxD -P	Data -P	
4	CNTR-P	Control signal P	
5	DGND	Signal ground	
6	VP	Supply voltage	
7	-	Reserved	
8	RxD / TxD -N	Data -N	
9		Reserved	

Table 2-18: Connection X20

Connector

A PROFIBUS connector must be used to connect to the 9 pole PROFIBUS outlet because the bus terminal resistors are in this connector. The possible PROFIBUS connectors with different cable outlets are illustrated below.

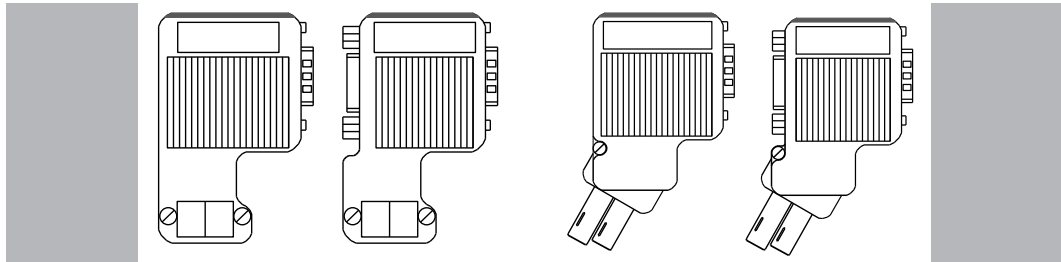

Figure 2-4: PROFIBUS connector

Bus terminal resistors

For the first and last bus nodes, the terminal resistors must be switched on. Otherwise data transmission will not function properly.

The shielding must be applied generously and on both sides.

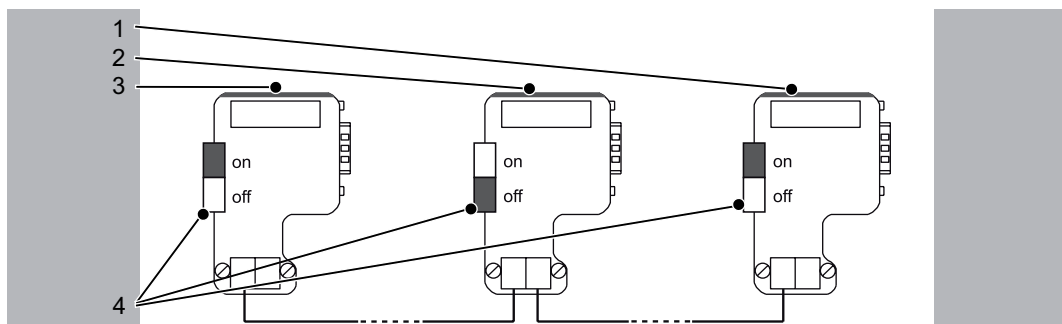

Figure 2-5: Position of the bus terminal resistors

1	Last bus slave
2	Nth bus slave
3	First bus slave
4	Bus terminator

3 Type code

Product ID code

C400 / 10 / 1 / 1 / 1 / 00

HW-Variant

Processor
1 = Intel Pentium M 600 MHz

RAM
1 = 256 MB

Flash memory
1 = 32 MB

Optional functions

