

PRO-M Series Power Supplies

NEW



Weidmüller's new PRO-M Series Switchmode Power Supplies offer a host of advantages. Available in 10 different versions, the 24 VDC PRO-M power supplies all feature a solid ultra-slim metal housing, and are designed to mount on a DIN-rail with no ventilation gap required between multiple units. This feature provides up to a 50% savings in space and allows the PRO-M to fit into the tightest spaces in control cabinets or machines.

These compact and efficient power supplies are optimized for machinery, with features that include overload resistance and high performance reserves. They also provide an increased level of reliability. Should one phase fail, the three-phase PRO-M power supply modules continue to work reliably in a two-phase operation.

The PRO-M Series power supplies are available in single-phase and three-phase versions from 70 W to 1000 W, making them particularly suited for use in many automation applications. The wide-ranging AC and DC inputs, broad operating temperature range and international approvals make the PRO-M supplies a strong choice.

- Slim housings for space saving installation in the cabinet
- DIN-rail mountable without any gap (no clearance necessary)
- Operating temperature range of -25°C to +70°C
- Autoselect Input for wide input range without any switch; for DC and AC voltages
- Power boost of 120% enables inductive and capacitive loads; additional starting capacity with up to a 2-minute boost
- Parallel connections allow simple power increase for up to five units without diode module
- MTBF > 500,000 Hours

Canada

Weidmüller, Canada
10 Spy Court
Markham, Ontario L3R 5H6
Telephone: (800) 268-4080
Facsimile: (877) 300-5635
Email: info1@weidmuller.ca
Website: www.weidmuller.ca

Mexico

Weidmüller, Mexico
Blvd. Hermanos Serdán 698
Col. San Rafael Oriente
Puebla, Puebla, Mexico
C.P. 72029
Telephone: 01 222 2686267
Facsimile: 01 222 2686219
Email: clientes@weidmuller.com.mx
Website: www.weidmuller.com.mx

United States

Weidmüller
821 Southlake Blvd.
Richmond, Virginia 23236
Telephone: (800) 849-9343
Facsimile: (804) 379-2593
Email: info@weidmuller.com
Website: www.weidmuller.com

Weidmüller 



Technical Data

General Specifications

Current limiting	> 120 % I _N
Ambient temp. operating / storage	-25 °C ... +70 °C / -40 °C ... +85 °C
Max. perm. air humidity (operation)	20 %...95 % RH
Protection class	IP20
Class of protection	I, with PE connection
Overvoltage category	II
Pollution severity	2
Insulation voltage	4 kV I/O / 2 kV I/ground / 0.5 kV O/ground
MTBF	> 500,000 h acc. to IEC 1709 (SN29500)
Protection against reverse voltages from the load	30...35 V DC
Parallel connection option	yes, without diode module
Housing version	metal, corrosion resistant
Indication	operation, green LED
Mounting position, installation notice	horizontal on mounting rail TS35, 50 mm spacing top and bottom for free air circulation, can be mounted side by side with no space in between

EMC / shock / vibration

Noise emission acc. to EN55022	Class B
Noise immunity tests acc. to	EN61000-4-2 (ESD), EN61000-4-3 and EN61000-4-8 (Fields), EN61000-4-4 (Burst), EN61000-4-5 (Surge), EN610004-6 (conducted), EN61000-4-11 (Dips)
Limiting of mains voltage harmonic currents	Acc. to EN 61000-3-2
Resistance against vibration and shock	Acc. to EN50178, shock: 5g in all directions
Electrical safety (applied standards)	
Electrical equipment of machines	Acc. to EN60204
Safety transformers for switched-mode power units	Acc. to EN61558-2-17
Machinery with electronic equipment	Acc. to EN50178 / VDE0160
Safety extra-low voltage	SELV acc. to EN60950, PELV acc. to EN60204
Protective separation / protection against electrical shock	VDE0100-410 / acc. to DIN57100-410
Protection against dangerous shock currents	Acc. to VDE0106-101

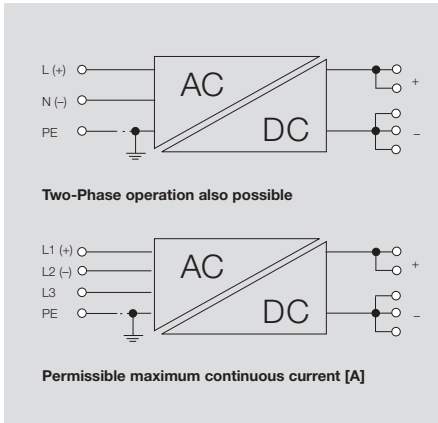

Max. limiting average on state current [A]

Type\Temp.	45°C	50°C	55°C	60°C	65°C	70°C
1ph 24V / 3A	3.6	3.3	3.0	2.6	2.2	1.8
1ph 24V / 5A	6	5.5	5.0	4.4	3.8	3.1
1ph 24V / 7.5A	9	8.6	8.25	7.5	6.75	5.6
1ph 24V / 10A	12	11.5	11	10	9	7.5
1ph 24V / 20A	24	23	22	20	18	15
1ph 24V / 40A	48	46	44	40	36	30
3ph 24V / 5A	6	5.75	5.5	5	4.5	3.7
3ph 24V / 10A	12	11.5	11	10	9	7.5
3ph 24V / 20A	24	23	22	20	18	15
3ph 24V / 40A	48	46	44	40	36	30

Project Planning Data

Type	24 V / 3 A	24 V / 5 A	24 V / 7.5 A	24 V / 10 A	24 V / 20 A	24 V / 40 A	24 V / 5 A	24 V / 10 A	24 V / 20 A	24 V / 40 A
	1 - phase						3 - phase			
Rated input voltage	100...240 V AC						3 x 400...500 V AC			
Mains voltage range	85...264 V AC						3 x 320...575 V AC			
Mains input current (max/min)	1.9...0.6 A	3.2...1.0 A	4.7...1.6 A	3.2...1.1 A	6.4...2.1 A	12.7...4.1 A	0.4...0.2 A	0.7...0.4 A	1.3...0.7 A	2.6...1.2 A
Rec. fuse [char.]	2 A / D I	4 A / D I	6 A / D I	6 A / D I	10 A / D I	16 A / D I	2 A / D I	2 A / D I	2 A / D I	4 A / D I
	6 A, [B]	6 A, [B]	16 A, [B]	16 A, [B]	20 A, [B]	25 A, [B]	-	-	-	10 A, [B]
	2...4 A, [C]	3...5 A, [C]	5...10 A, [C]	5...10 A, [C]	10...12 A, [C]	14...16 A, [C]	1...2 A, [C]	2...3 A, [C]	3...5 A, [C]	6...8 A, [C]
Efficiency @ 230VAC	88%	89 %	90 %	90 %	> 90 %	> 90 %	90 %	> 90 %	> 90 %	> 90 %
Rated power loss [W]	10 W	15 W	20 W	27 W	53 W	106 W	13 W	26 W	53 W	107 W
Installation width mm	33	40	50	60	115	140	40	60	115	140
Input terminals	Screw connection									
Conductor, solid min/max mm ²	0.5...6			0.5...6			0.5...6		0.5...6	
Conductor, flexible min/max mm ²	0.5...2.5			0.5...2.5			0.5...2.5		0.5...2.5	
Conductor, AWG/kcmil min/max	26 / 12			26 / 10			26 / 12		26 / 12	
Output terminals	Screw connection									
Number plus/minus	2 / 2			2 / 3			2 / 3		2 / 3	
Conductor, solid min/max mm ²	0.5...6			0.5...6		0.5...16		0.5...6		0.5...16
Conductor, flexible min/max mm ²	0.5...2.5			0.5...2.5		2.5...10		0.5...2.5		2.5...0
Conductor, AWG/kcmil min/max	26 / 12			26 / 10		26 / 6		26 / 12		26 / 10

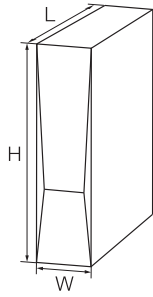

CP M SNT 70W 24V 3A



CP M SNT 120W 24V 5A



Derating Curve

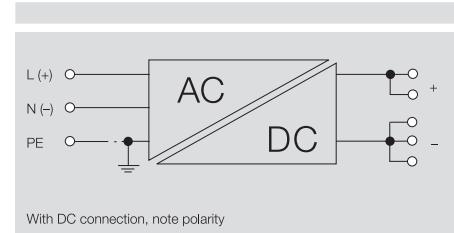
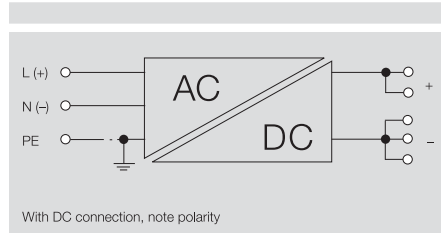
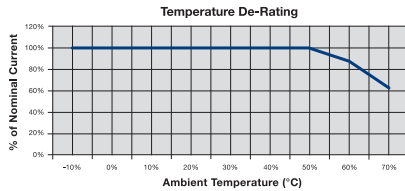

Ordering Data

Type	Part No.
CP M SNT 70W 24V 3A	8951330000

Type	Part No.
CP M SNT 120W 24V 5A	8951340000

Technical Data

Input Specifications

Rated input voltage
AC input voltage range
AC frequency range
DC input voltage range
AC current consumption
DC current consumption
Input fuse (internal)/Inrush current
Circuit Protection

100...240 V AC (wide-range input)
85...264 V AC
47...63 Hz
80...370 V DC
0.80 A @ 230 V AC / 1.5A @ 115 V AC
0.25 A @ 370 V DC / 1.1 A @ 80 V DC
yes/max. 20 A
2 A / DI, safety fuse
6 A, Char. B, Circuit breaker
2...4 A, Char. C, Circuit breaker

100...240 V AC (wide-range input)
85...264 V AC
47...63 Hz
80...370 V DC
1.3 A @ 230 V AC / 2.4 A @ 115 V AC
0.5 A @ 370 V DC / 1.8 A @ 80 V DC
yes/max. 30 A
4 A / DI, safety fuse
6 A, Char. B, Circuit breaker
3...5 A, Char. C, Circuit breaker

Output Specifications

Rated output voltage
Output voltage
Residual ripple, switching peaks
Rated output current @ V _{rated}
Continuous output current @ 24 V DC
Power boost @ 24 V DC, 60 °C

24 V DC ± 1 %
22.5...29.5 V DC (adjustable via potentiometer on front)
100 mV _{SS} @ 24 V DC, I _N
3 A @ 55 °C
3.6 A @ 45 °C
3.3 A @ 50 °C
1.8 A @ 70 °C
3.6 A for 1 min, ED=5 %

24 V DC ± 1 %
22.5...29.5 V DC (adjustable via potentiometer on front)
100 mV _{SS} @ 24 V DC, I _N
5 A @ 55 °C
6.0 A @ 45 °C
5.5 A @ 50 °C
3.1 A @ 70 °C
6 A for 1 min, ED=5 %

General Specifications

Efficiency
Power factor (approx.)
Mains buffering @ I _{rated}
Parallel connection option
Length x Width x Height
Weight

88 % @ 230 V AC / > 85 % @ 115 V AC
> 0.5 @ 230 V AC / > 0.53 @ 115 V AC
> 100 ms @ 230 V AC / > 20 ms @ 100 V AC
yes
125 x 33 x 130
0.69 kg

89 % @ 230 V AC / > 85 % @ 115 V AC
> 0.5 @ 230 V AC / > 0.53 @ 115 V AC
> 100 ms @ 230 V AC / > 20 ms @ 100 V AC
yes
125 x 40 x 130
0.8 kg

Approvals/Certifications

CE, cURus, UL508, CSA22.2 no.107

CE, cURus, UL508, CSA22.2 no.107

Connection Data

Type of connection
Number of terminals
Conductor cross-section, rigid min/max
Conductor cross-section, flexible min/max
Conductor cross-section, AWG/kcmil min/max

Input	Output
Screw connection	Screw Connection
3 for L/N/PE	4 (+/-)
0.5 / 6	0.5 / 6
0.5 / 2.5	0.5 / 2.5
26 / 12	26 / 12

Input	Output
Screw connection	Screw Connection
3 for L/N/PE	5 (+/-)
0.5 / 6	0.5 / 6
0.5 / 2.5	0.5 / 2.5
26 / 12	26 / 26

* Recommendation applies only for AC operation; the max. permissible operating voltage is to be observed in all cases!

* Recommendation applies only for AC operation; the max. permissible operating voltage is to be observed in all cases!

CP M SNT 180W 24V 7.5A

CP M SNT 250W 24V 10A

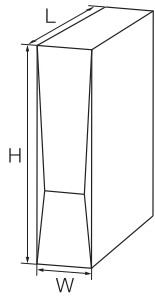

Derating Curve

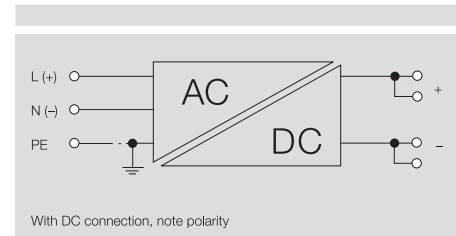
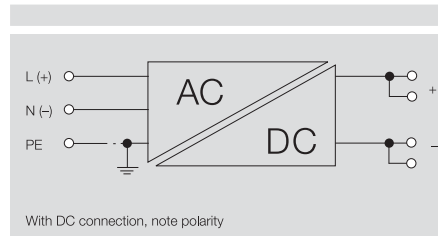
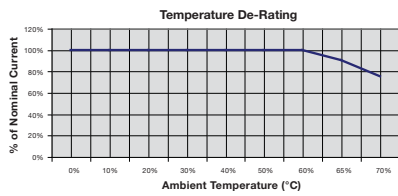

Ordering Data

Type	Part No.
CP M SNT 180W 24V 7.5A	8951350000

Type	Part No.
CP M SNT 250W 24V 10A	8951360000

Technical Data

Input Specifications

Rated input voltage	100...240 V AC (wide-range input)
AC input voltage range	85...264 V AC
AC frequency range	47...63 Hz
DC input voltage range	80...370 V DC
AC current consumption	1.9 A @ 230 V AC / 3.6 A @ 115 V AC
DC current consumption	0.6 A @ 370 V DC / 2.6 A @ 80 V DC
Input fuse (internal)/Inrush current	yes
Circuit Protection	6 A / DI, safety fuse 16 A, Char. B, Circuit breaker 5...10 A, Char. C, Circuit breaker

Rated input voltage	100...240 V AC (wide-range input)
AC input voltage range	85...264 V AC
AC frequency range	47...63 Hz
DC input voltage range	80...370 V DC
AC current consumption	1.9 A @ 230 V AC / 3.6 A @ 115 V AC
DC current consumption	0.6 A @ 370 V DC / 2.6 A @ 80 V DC
Input fuse (internal)/Inrush current	yes
Circuit Protection	6 A / DI, safety fuse 16 A, Char. B, Circuit breaker 5...10 A, Char. C, Circuit breaker

Rated input voltage	100...240 V AC (wide-range input)
AC input voltage range	85...264 V AC
AC frequency range	47...63 Hz
DC input voltage range	80...370 V DC
AC current consumption	1.3 A @ 230 V AC / 2.5 A @ 115 V AC
DC current consumption	0.9 A @ 370 V DC / 3.4 A @ 80 V DC
Input fuse (internal)/Inrush current	yes
Circuit Protection	6 A / DI, safety fuse 16 A, Char. B, Circuit breaker 5...10 A, Char. C, Circuit breaker

Output Specifications

Rated output voltage	24 V DC ± 1 %
Output voltage	22.5...29.5 V DC (adjustable via potentiometer on front)
Residual ripple, switching peaks	100 mVss @ 24 V DC, IN
Rated output current @ V _{rated}	7.5 A @ 60 °C
Continuous output current @ 24 V DC	9.0 A @ 45 °C 8.2 A @ 55 °C 5.6 A @ 70 °C
Power boost @ 24 V DC, 60 °C	9 A for 1 min, ED=5 %

Rated output voltage	24 V DC ± 1 %
Output voltage	22.5...29.5 V DC (adjustable via potentiometer on front)
Residual ripple, switching peaks	100 mVss @ 24 V DC, IN
Rated output current @ V _{rated}	7.5 A @ 60 °C
Continuous output current @ 24 V DC	9.0 A @ 45 °C 8.2 A @ 55 °C 5.6 A @ 70 °C
Power boost @ 24 V DC, 60 °C	9 A for 1 min, ED=5 %

Rated output voltage	24 V DC ± 1 %
Output voltage	22.5...29.5 V DC (adjustable via potentiometer on front)
Residual ripple, switching peaks	100 mVss @ 24 V DC, IN
Rated output current @ V _{rated}	10 A @ 60 °C
Continuous output current @ 24 V DC	12 A @ 45 °C 11 A @ 55 °C 7.5 A @ 70 °C
Power boost @ 24 V DC, 60 °C	12 A for 1 min, ED=5 %

General Specifications

Efficiency	90 % @ 230 V AC / > 85 % @ 115 V AC
Power factor (approx.)	> 0.5 @ 230 V AC / > 0.53 @ 115 V AC
Mains buffering @ I _{rated}	> 40 ms @ 230 V AC / > 20 ms @ 100 V AC
Parallel connection option	yes
Length x Width x Height	125 x 50 x 130 mm
Weight	1.0 kg

Efficiency	90 % @ 230 V AC / > 85 % @ 115 V AC
Power factor (approx.)	> 0.98 @ 230 V AC / > 0.98 @ 115 V AC
Mains buffering @ I _{rated}	> 40 ms @ 230 V AC / > 20 ms @ 100 V AC
Parallel connection option	yes
Length x Width x Height	150 x 60 x 130 mm
Weight	1.2 kg

Efficiency	90 % @ 230 V AC / > 85 % @ 115 V AC
Power factor (approx.)	> 0.98 @ 230 V AC / > 0.98 @ 115 V AC
Mains buffering @ I _{rated}	> 40 ms @ 230 V AC / > 20 ms @ 100 V AC
Parallel connection option	yes
Length x Width x Height	150 x 60 x 130 mm
Weight	1.2 kg

Approvals/Certifications

CE, cURus, UL508, CSA22.2 no.107

CE, cURus, UL508, CSA22.2 no.107

Connection Data

Type of connection	Screw connection
Number of terminals	3 for L/N/PE
Conductor cross-section, rigid min/max	0.5 / 6 mm ²
Conductor cross-section, flexible min/max	0.5 / 2.5 mm ²
Conductor cross-section, AWG/kcmil min/max	26 / 12

Input	Output
Screw connection	Screw Connection
3 for L/N/PE	5 (++/--)
0.5 / 6	0.5 / 6
0.5 / 2.5	0.5 / 2.5
26 / 12	26 / 12

Input	Output
Screw connection	Screw Connection
3 for L/N/PE	5 (++/--)
0.5 / 6	0.5 / 6
0.5 / 2.5	0.5 / 2.5
26 / 12	26 / 12

* Recommendation applies only for AC operation; the max. permissible operating voltage is to be observed in all cases!

* Recommendation applies only for AC operation; the max. permissible operating voltage is to be observed in all cases!

CP M SNT 500W 24V 20A

CP M SNT 1000W 24V 40A



Derating Curve

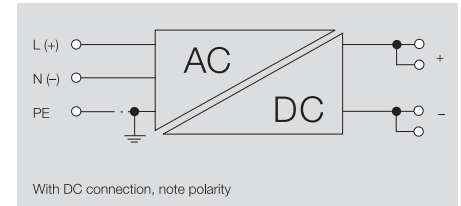
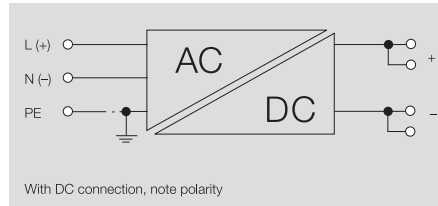
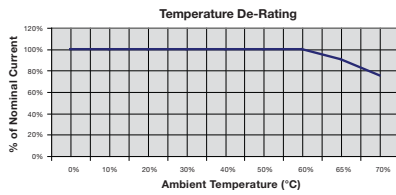

Ordering Data

Type	Part No.
CP M SNT 500W 24V 20A	8951370000

Type	Part No.
CP M SNT 1000W 24V 40A	8951380000

Technical Data

Input Specifications

Rated input voltage
AC input voltage range
AC frequency range
DC input voltage range
AC current consumption
DC current consumption
Input fuse (internal)/Inrush current
Circuit Protection

100...240 V AC wide-range input
85...264 V AC
47...63 Hz
80...370 V DC
2.5 A @ 230 V AC / 4.9 A @ 115 V AC
1.6 A @ 370 V DC / 6.8 A @ 80 V DC
yes
10 A / DI, safety fuse
20 A, Char. B, Circuit breaker
10...12 A, Char. C, Circuit breaker

100...240 V AC (wide-range input)
85...264 V AC
47...63 Hz
80...370 V DC
4.9 A @ 230 V AC / 9.6 A @ 115 V AC
3.0 A @ 370 V DC / 13.5 A @ 80 V DC
yes
16 A / DI, safety fuse
25 A, Char. B, Circuit breaker
14...16 A, Char. C, Circuit breaker

Output Specifications

Rated output voltage
Output voltage
Residual ripple, switching peaks
Rated output current @ V _{rated}
Continuous output current @ 24 V DC
Power boost @ 24 V DC, 60 °C

24 V DC ± 1 %
22.5...29.5 V DC (adjustable via potentiometer on front)
100 mV _{SS} @ 24 V DC, I _N
20 A @ 60 °C
24 A @ 45 °C
22 A @ 55 °C
15 A @ 70 °C
24 A for 1 min, ED=5 %

24 V DC ± 1 %
22.5...29.5 V DC (adjustable via potentiometer on front)
100 mV _{SS} @ 24 V DC, I _N
40 A @ 60 °C
48 A @ 45 °C
44 A @ 55 °C
30 A @ 70 °C
48 A for 1 min, ED=5 %

General Specifications

Efficiency
Power factor (approx.)
Mains buffering @ I _{rated}
Parallel connection option
Length x Width x Height
Weight

> 90 % @ 230 V AC / > 85 % @ 115 V AC
> 0.98 @ 230 V AC / > 0.98 @ 115 V AC
> 40 ms @ 230 V AC / > 20 ms @ 100 V AC
yes
150 x 121 x 130
1.5 kg

> 90 % @ 230 V AC / > 85 % @ 115 V AC
> 0.98 @ 230 V AC / > 0.98 @ 115 V AC
> 40 ms @ 230 V AC / > 20 ms @ 100 V AC
yes
150 x 180 x 130
1.5 kg

Approvals/Certifications

CE, cURus, UL508, CSA22.2 no.107

CE, cURus, UL508, CSA22.2 no.107

Connection Data

Type of connection
Number of terminals
Conductor cross-section, rigid min/max
Conductor cross-section, flexible min/max
Conductor cross-section, AWG/kcmil min/max

Input	Output
Screw connection	Screw Connection
3 for L/N/PE	5 (+/+/-)
0.5 / 6	0.5 / 6
0.5 / 2.5	0.5 / 2.5
26 / 10	26 / 10

Input	Output
Screw connection	Screw Connection
3 for L/N/PE	5 (+/+/-)
0.5 / 6	0.5 / 16
0.5 / 2.5	2.5 / 10
26 / 10	26 / 6

* Recommendation applies only for AC operation; the max. permissible operating voltage is to be observed in all cases!

* Recommendation applies only for AC operation; the max. permissible operating voltage is to be observed in all cases!

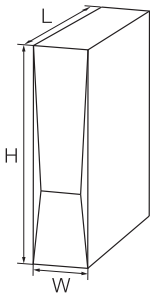

CP M SNT3 120W 24V 5A



CP M SNT3 250W 24V 10A



Derating Curve

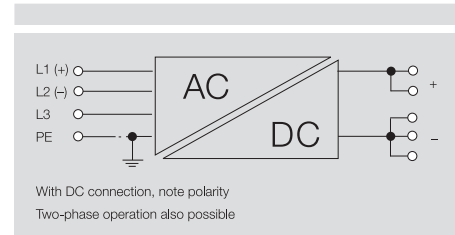
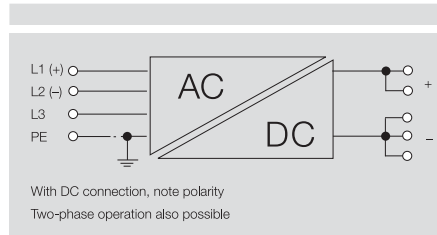
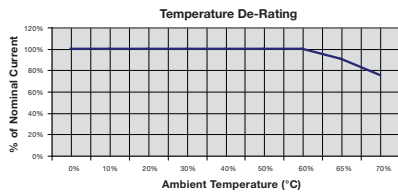

Ordering Data

Type	Part No.
CP M SNT3 120W 24V 5A	8951390000

Type	Part No.
CP M SNT3 250W 24V 10A	8951400000

Technical Data

Input Specifications	
Rated input voltage	
AC input voltage range	
AC frequency range	
DC input voltage range	
AC current consumption	
DC current consumption	
Input fuse (internal)	
Circuit Protection	

3 x 400...3 x 500 V AC (wide-range input)
3 x 320...3 x 575 V AC / 2 x 360...2 x 575 V AC
47...63 Hz
450...800 V DC (max. 500 V DC acc. to UL508)
0.25 A @ 3 x 500 V AC / 0.3 A @ 3 x 400 V AC
0.2 A @ 800 V DC / 0.4 A @ 450 V DC
no
2 A / DI, safety fuse
1...2 A, Char. C, Circuit breaker

3 x 400...3 x 500 V AC (wide-range input)
3 x 320...3 x 575 V AC / 2 x 360...2 x 575 V AC
47...63 Hz
450...800 V DC (max. 500 V DC acc. to UL508)
0.5 A @ 3 x 500 V AC / 0.6 A @ 3 x 400 V AC
0.4 A @ 800 V DC / 0.7 A @ 450 V DC
no
2 A / DI, safety fuse
2...3 A, Char. C, Circuit breaker

Output Specifications	
Rated output voltage	
Output voltage	
Residual ripple, switching peaks	
Rated output current @ V _{rated}	
Continuous output current @ 24 V DC	
Power boost @ 24 V DC, 60 °C	

24 V DC ± 1 %
22.5...29.5 V DC (adjustable via potentiometer on front)
100 mV _{SS} @ 24 V DC, I _N
5 A @ 60 °C
6.0 A @ 45 °C
5.5 A @ 55 °C
3.7 A @ 70 °C
6 A for 1 min, ED=5 %

24 V DC ± 1 %
22.5...29.5 V DC (adjustable via potentiometer on front)
100 mV _{SS} @ 24 V DC, I _N
10 A @ 60 °C
12 A @ 45 °C
11 A @ 55 °C
7.5 A @ 70 °C
12 A for 1 min, ED=5 %

General Specifications	
Efficiency	
Power factor (approx.)	
Mains buffering @ I _{rated}	
Parallel connection option	
Length x Width x Height	mm
Weight	

90 % @ 3 x 500 V AC / > 90 % @ 3 x 400 V AC
> 0.75 @ 3 x 500 V AC / > 0.78 @ 3 x 400 V AC
> 25 ms @ 3 x 500 V AC / > 20 ms @ 3 x 400 V AC
yes
125 x 40 x 130
0.55 kg

90 % @ 3 x 500 V AC / > 90 % @ 3 x 400 V AC
> 0.75 @ 3 x 500 V AC / > 0.78 @ 3 x 400 V AC
> 25 ms @ 3 x 500 V AC / > 20 ms @ 3 x 400 V AC
yes
150 x 60 x 130
0.9 kg

Approvals/Certifications	

CE, cURus, UL508, CSA22.2 no.107

CE, cURus, UL508, CSA22.2 no.107

Connection Data	
Type of connection	
Number of terminals	
Conductor cross-section, rigid min/max	mm ²
Conductor cross-section, flexible min/max	mm ²
Conductor cross-section, AWG/kcmil min/max	

Input	Output
Screw connection	Screw Connection
4 for L1/L2/L3/PE	5 (++)/(-)
0.5 / 6	0.5 / 6
0.5 / 2.5	0.5 / 2.5
26 / 12	26 / 12

Input	Output
Screw connection	Screw Connection
4 for L1/L2/L3/PE	5 (++)/(-)
0.5 / 6	0.5 / 6
0.5 / 2.5	0.5 / 2.5
26 / 12	26 / 12

* Recommendation applies only for AC operation; the max. permissible operating voltage is to be observed in all cases!

* Recommendation applies only for AC operation; the max. permissible operating voltage is to be observed in all cases!

CP M SNT3 500W 24V 20A

CP M SNT3 1000W 24V 40A

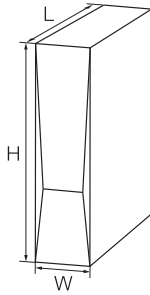

Derating Curve

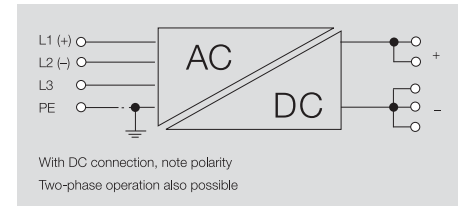
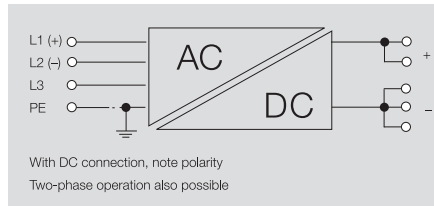
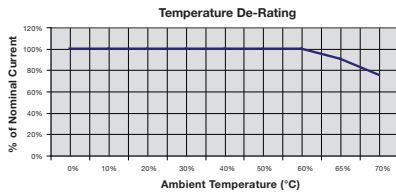

Ordering Data

Type	Part No.
CP M SNT3 500W 24V 20A	8951410000

Type	Part No.
CP M SNT3 1000W 24V 40A	8951420000

Technical Data

Input Specifications

Rated input voltage	3 x 400...3 x 500 V AC (wide-range input)
AC input voltage range	3 x 320...3 x 575 V AC / 2 x 360...2 x 575 V AC
AC frequency range	47...63 Hz
DC input voltage range	450...800 V DC (max. 500 V DC acc. to UL508)
AC current consumption	0.9 A @ 3 x 500 V AC / 1.1 A @ 3 x 400 V AC
DC current consumption	0.7 A @ 800 V DC / 1.3 A @ 450 V DC
Input fuse (internal)	no
Circuit Protection	2 A / DI, safety fuse 3...5 A, Char. C, Circuit breaker

Rated input voltage	3 x 400...3 x 500 V AC (wide-range input)
AC input voltage range	3 x 320...3 x 575 V AC / 2 x 360...2 x 575 V AC
AC frequency range	47...63 Hz
DC input voltage range	450...800 V DC (max. 500 V DC acc. to UL508)
AC current consumption	0.9 A @ 3 x 500 V AC / 1.1 A @ 3 x 400 V AC
DC current consumption	0.7 A @ 800 V DC / 1.3 A @ 450 V DC
Input fuse (internal)	no
Circuit Protection	2 A / DI, safety fuse 3...5 A, Char. C, Circuit breaker

Rated input voltage	3 x 400...3 x 500 V AC (wide-range input)
AC input voltage range	3 x 320...3 x 575 V AC / 2 x 360...2 x 575 V AC
AC frequency range	47...63 Hz
DC input voltage range	450...800 V DC (max. 500 V DC acc. to UL508)
AC current consumption	1.8 A @ 3 x 500 V AC / 2.1 A @ 3 x 400 V AC
DC current consumption	1.4 A @ 800 V DC / 2.5 A @ 450 V DC
Input fuse (internal)	no
Circuit Protection	4 A / DI, safety fuse 10 A, Char. B, Circuit breaker 6...8 A, Char. C, Circuit breaker

Output Specifications

Rated output voltage	24 V DC ± 1 %
Output voltage	22.5...29.5 V DC (adjustable via potentiometer on front)
Residual ripple, switching peaks	100 mV _{SS} @ 24 V DC, I _N
Rated output current @ V _{rated}	20 A @ 60 °C
Continuous output current @ 24 V DC	24 A @ 45 °C 22 A @ 55 °C 15 A @ 70 °C
Power boost @ 24 V DC, 60 °C	24 A for 1 min, ED=5 %

Rated output voltage	24 V DC ± 1 %
Output voltage	22.5...29.5 V DC (adjustable via potentiometer on front)
Residual ripple, switching peaks	100 mV _{SS} @ 24 V DC, I _N
Rated output current @ V _{rated}	40 A @ 60 °C
Continuous output current @ 24 V DC	48 A @ 45 °C 44 A @ 55 °C 30 A @ 70 °C
Power boost @ 24 V DC, 60 °C	48 A for 1 min, ED=5 %

Rated output voltage	24 V DC ± 1 %
Output voltage	22.5...29.5 V DC (adjustable via potentiometer on front)
Residual ripple, switching peaks	100 mV _{SS} @ 24 V DC, I _N
Rated output current @ V _{rated}	40 A @ 60 °C
Continuous output current @ 24 V DC	48 A @ 45 °C 44 A @ 55 °C 30 A @ 70 °C
Power boost @ 24 V DC, 60 °C	48 A for 1 min, ED=5 %

General Specifications

Efficiency	> 90 % @ 3 x 500 V AC / > 91 % @ 3 x 400 V AC
Power factor (approx.)	> 0.75 @ 3 x 500 V AC / > 0.78 @ 3 x 400 V AC
Mains buffering @ I _{rated}	> 25 ms @ 3 x 500 V AC / > 20 ms @ 3 x 400 V AC
Parallel connection option	yes
Length x Width x Height	150 x 121 x 130 mm
Weight	1.5 kg

Efficiency	> 90 % @ 3 x 500 V AC / 92 % @ 3 x 400 V AC
Power factor (approx.)	> 0.75 @ 3 x 500 V AC / > 0.78 @ 3 x 400 V AC
Mains buffering @ I _{rated}	> 25 ms @ 3 x 500 V AC / > 20 ms @ 3 x 400 V AC
Parallel connection option	yes
Length x Width x Height	150 x 180 x 130 mm
Weight	2.9 kg

Efficiency	> 90 % @ 3 x 500 V AC / 92 % @ 3 x 400 V AC
Power factor (approx.)	> 0.75 @ 3 x 500 V AC / > 0.78 @ 3 x 400 V AC
Mains buffering @ I _{rated}	> 25 ms @ 3 x 500 V AC / > 20 ms @ 3 x 400 V AC
Parallel connection option	yes
Length x Width x Height	150 x 180 x 130 mm
Weight	2.9 kg

Approvals/Certifications

CE, cURus, UL508, CSA22.2 no.107

CE, cURus, UL508, CSA22.2 no.107

Connection Data

Type of connection	Screw connection
Number of terminals	4 for L1/L2/L3/PE
Conductor cross-section, rigid min/max	0.5 / 6 mm ²
Conductor cross-section, flexible min/max	0.5 / 2.5 mm ²
Conductor cross-section, AWG/kcmil min/max	26 / 10

Input	Output
Screw connection	Screw Connection
4 for L1/L2/L3/PE	5 (+/+/-)
0.5 / 6	0.5 / 6
0.5 / 2.5	0.5 / 2.5
26 / 10	26 / 10

Input	Output
Screw connection	Screw Connection
4 for L1/L2/L3/PE	5 (+/+/-)
0.5 / 6	0.5 / 16
0.5 / 2.5	0.5 / 10
26 / 10	26 / 6

* Recommendation applies only for AC operation; the max. permissible operating voltage is to be observed in all cases!

* Recommendation applies only for AC operation; the max. permissible operating voltage is to be observed in all cases!

Diode Modules for Redundancy



CP DM 10 10A per Input Diode Module

CP DM 20 20A per Input Diode Module



Approvals:



Derating Curve

3/5/10/20A

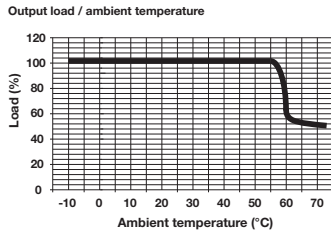

Schematic

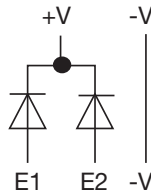

Schematic

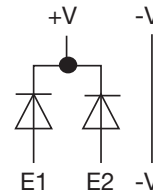

Ordering Data

Type	Qty.	Part No.
CP DM 10	1	8710620000

Type	Qty.	Part No.
CP DM 10	1	8710620000

Type	Qty.	Part No.
CP DM 20	1	8768650000

Technical Data

Input	Input voltage	40 VDC max.
	Input current	10 A per input max.
Output	Output voltage	$V_{in} - 0.5$ typ.
	Output current	20 A max.

Input	Input voltage	40 VDC max.
	Input current	10 A per input max.
Output	Output voltage	$V_{in} - 0.5$ typ.
	Output current	20 A max.

Input	Input voltage	40 VDC max.
	Input current	20 A per input max.
Output	Output voltage	$V_{in} - 0.5$ typ.
	Output current	40 A max.

General Specifications

Temperature	Operating	-10°C...+55°C (+14°F...+131°F)
	Storage	-20°C...+85°C (-4°F...+185°F)
Efficiency under max. load		approx. 95.5% at 24 VDC
Mount onto mounting rail		Mounting rail TS35 to DIN 50022
Mounting position		Horizontal
Mounting		Clearance: side ≥ 4 cm; above/below ≥ 10 cm
Weight		approx. 0.15 kg (0.33 lbs.)
Dimensions (L x W x H)		125.0 x 55.5 mm x 110.0 (4.92 x 2.19 x 4.33 in.)
Type of Connection		Screw
Clamping area input (nominal / min. / max.)		4 / 0.13 / 6 mm ² (12 / 26 / 10 AWG)
Clamping area output (nominal / min. / max.)		4 / 0.13 / 6 mm ² (12 / 26 / 10 AWG)
Indication signals	Voltage	None

Temperature	Operating	-10°C...+55°C (+14°F...+131°F)
	Storage	-20°C...+85°C (-4°F...+185°F)
Efficiency under max. load		approx. 95% at 24 VDC
Mount onto mounting rail		Mounting rail TS35 to DIN 50022
Mounting position		Horizontal
Mounting		Clearance: side ≥ 4 cm; above/below ≥ 10 cm
Weight		approx. 0.5 kg (1.1 lbs.)
Dimensions (L x W x H)		125.0 x 55.5 mm x 110.0 (4.92 x 2.19 x 4.33 in.)
Type of Connection		Screw
Clamping area input (nominal / min. / max.)		4 / 0.13 / 6 mm ² (12 / 26 / 10 AWG)
Clamping area output (nominal / min. / max.)		10.0 / 0.32 / 16.0 mm ² (8 / 22 / 6 AWG)
Indication signals	Voltage	None

Temperature	Operating	-10°C...+55°C (+14°F...+131°F)
	Storage	-20°C...+85°C (-4°F...+185°F)
Efficiency under max. load		approx. 95% at 24 VDC
Mount onto mounting rail		Mounting rail TS35 to DIN 50022
Mounting position		Horizontal
Mounting		Clearance: side ≥ 4 cm; above/below ≥ 10 cm
Weight		approx. 0.5 kg (1.1 lbs.)
Dimensions (L x W x H)		125.0 x 55.5 mm x 110.0 (4.92 x 2.19 x 4.33 in.)
Type of Connection		Screw
Clamping area input (nominal / min. / max.)		4 / 0.13 / 6 mm ² (12 / 26 / 10 AWG)
Clamping area output (nominal / min. / max.)		10.0 / 0.32 / 16.0 mm ² (8 / 22 / 6 AWG)
Indication signals	Voltage	None

	Alarm	None
Fault Relay	Voltage	None
	Current	None
	Configuration	None
	Set point	None
Other	Voltage drop input-output	0.5 V typ.
	Fan	None

	Alarm	None
Fault Relay	Voltage	None
	Current	None
	Configuration	None
	Set point	None
Other	Voltage drop input-output	0.5 V typ.
	Fan	None

	Alarm	None
Fault Relay	Voltage	None
	Current	None
	Configuration	None
	Set point	None
Other	Voltage drop input-output	0.5 V typ.
	Fan	None

Terminations	Input/output	N/A
	Alarm contact	N/A

Terminations	Input/output	N/A
	Alarm contact	N/A

Terminations	Input/output	N/A
	Alarm contact	N/A

Approvals/Certifications

cULus 508 Listed, CE

cULus 508 Listed, CE